

# ALFA TP 800



Kaynak Robot  
Welding Robot



Toz Boya  
Powder Paint



Test Edilmiştir  
Tested



2 Yıl Garanti  
2 Years Warranty

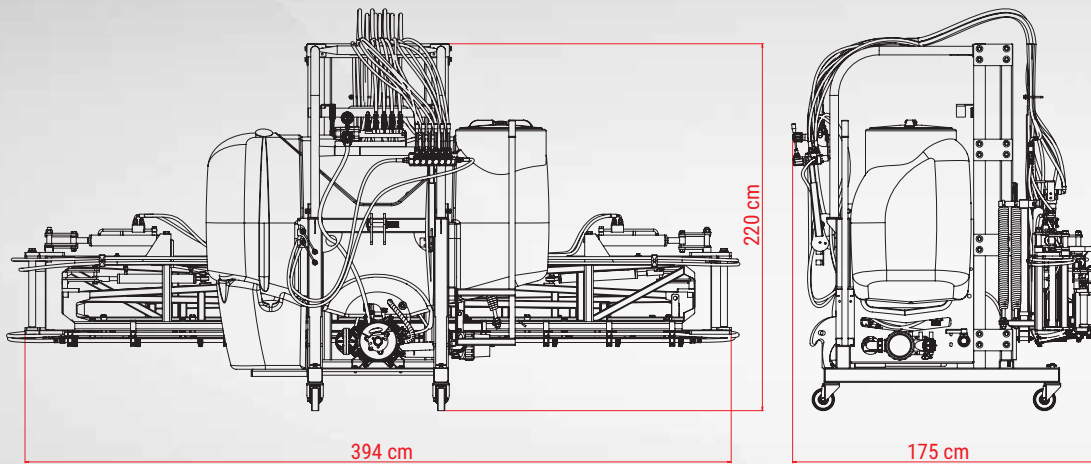

### Yükleme Adetleri / Loading Pcs



3



6



3



9

### Teknik Özellikler / Technical Specifications

Pompa Modeli Pump	Piston membranlı Piston diaphragm	Önallar C145
Pompa Debisi Pump Flowrate	l/dk l/min	145
Pompa Basıncı Pump Pressure	Bar	50
Kontrol Paneli Control Panel		OPR 40-5
İş Genişliği Working Width	m	18
Nozul Tipi Nozzle		Konik hüzmeli pirinç Conic beamed and clamped
Nozul Sayısı Nr. Of Nozzle		37
Nozullar Arası Mesafe The Distance Between Nozzle	cm	50
İlaçlama Kolu Yüksekliği Ayarı Boom Height Adjustment		Hidrolik Hydraulic
İlaçlama Kolu Katlanması Boom Opening Adjustment		Manuel Manual
Gereken Traktör Gücü Required Power	BG HP	70-90
Çalışma Devri Speed	dev/dk RPM	540
Ağırlık Weight	kg	849



Basınçlı suyu süzerek ilaçlama verimini yükseltir.

*Productivity by filtering pressured water.*



Makinenin trafikte farkedilmesini sağlar.

*Enables to be easily noticeable in the traffic machine.*



Kolun hidrolik kumanda ile kolayca açılıp kapanmasını sağlar.

*Provides to work easier the boom by the help of hydraulic regulator.*



Uzun ömürlü ve temizlenebilir nozul homojen ilaçlama yapar.

*Long-lasting and cleanable nozzle provides homogeneous disinfection.*



Araziye göre kolun eğimini ayarlar.

*Adjusts the pitch of boom according to terrain condition.*



Depo yıkama sistemi.  
*Tank cleaning system.*



Dökümünden montajına kadar kendi imalatımız 4 membranlı C145 pompa sınıfında en iyi performansa sahiptir.

*The best quality 4 membrane C145 pump which is manufactured by our factory is the most efficient product of its segment.*



İlaçlama sonrasında depoda kalan suyun tahliyesini hızlı bir şekilde gerçekleştirir.

*Fast removing of remained water on the tank after disinfection.*



Temizlenebilir filtre ilaçlamanın sağlıklı yapılabilmesini sağlar.

*Cleanable filter enables homogenous spraying.*



Depoda kalan su miktarını hassas ölçen şamandıralı gösterge.

*Sensitive float indicator which quantifies of residual water in the tank.*

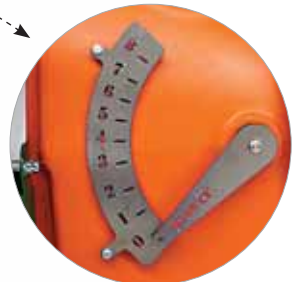

Depo Kapağı  
*Tank Lid*



Hidrolik liflerin uzaktan kontrolünü sağlar.

*Provides the distant control of hydraulic lifts.*



Homojen ve hassas ilaçlama normu sağlar.

*Homogeneous and sensitive disinfection.*



Kumanda ve kol arasındaki hortumların düzenli olmasına yarar.

*Cable canals support the hoses between regulator and boom against dam.*



Ana depodan bağımsız el yıkama tankı temiz su ihtiyacını karşılar.

*Hand washing tank apart from main tank supplies clean water.*

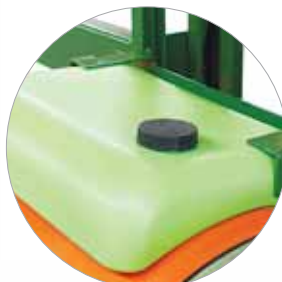



# ALFA TP

## C145 Pompa Randıman Değerleri / C145 Pump Productivity Rates

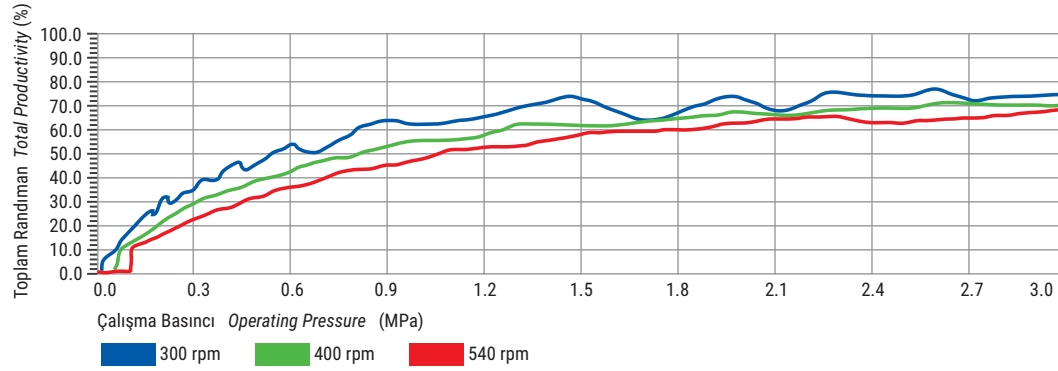

## C145 Pompa Verdi Değerleri / C145 Pump Flowrate Rates

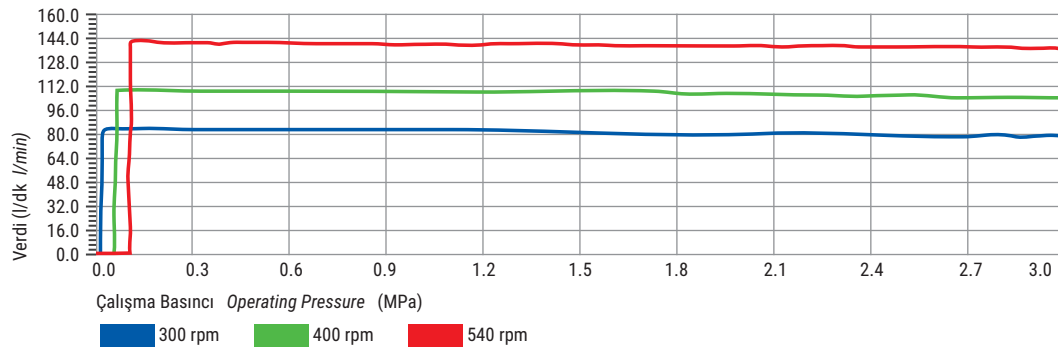

## Makine Çalışma Sistemi / Machine Working Principle

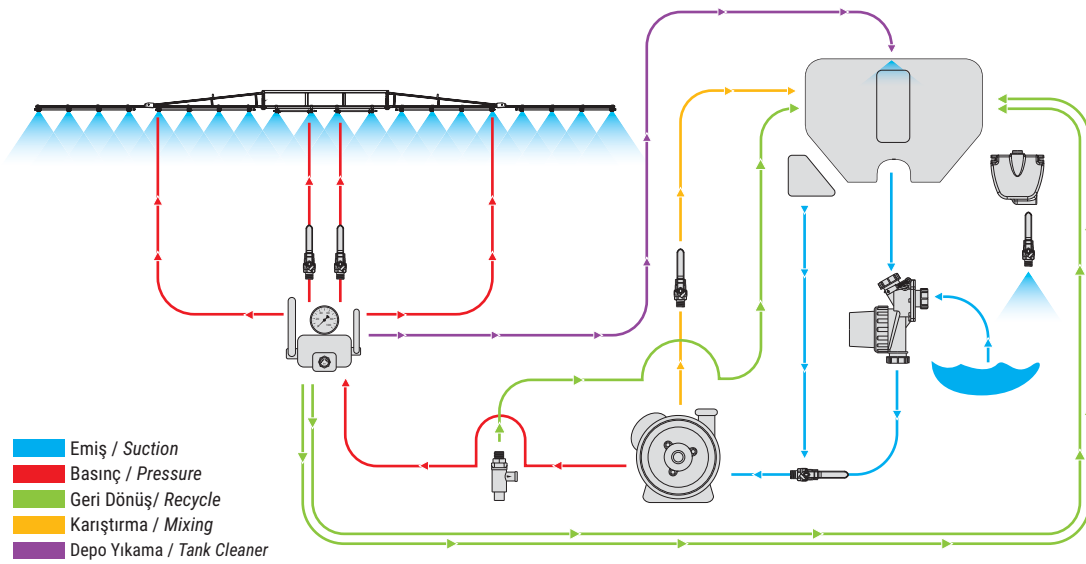

## Depo Doldurucusu Test Sonuçları / Test Results Of Filter

Hidrolik tip venturi depo doldurucusunun;  
Alfa TP 800 : 9 dk 2 sn  
Alfa TP 1000 : 11 dk 1 sn'de  
3 mpa basınçta 540 devirde doldurduğu tespit edilmiştir.

It is determined that hydraulic type venturi tank filler fills the  
Alfa TP 800 : 9 min. 2 sec.  
Alfa TP 1000 : 11 min. 1 sec.  
under operating at 3.0 MPa and 540 rpm cycle.

Bu değerler test ortamında elde edilmiş olup,  
şartlara bağlı olarak değişiklik gösterebilir.

These values are obtained in the test environment  
and may vary depending on the conditions.

## Hortum Test Sonuçları / Test Results Of Hose

Makinada bulunan hortumların, hortum deney standında çalışma basıncının 3 katı statik basınç altında (9.0 MPa) deforme olmadığı, çap ve form değişikliğine uğramadığı tespit edilmiştir.

Any deformation is not detected on the hoses which are used on the machine, in spite of practicing pressure over three times (9.0 MPa) than operating pressure.

## Süzgeçler / Sieves

Kullanım Yeri Place Of Use	Tipi Type	Malzeme Material Type	Delik Sayısı adet/cm <sup>2</sup> Hole Quantity pcs/cm <sup>2</sup>	Süzme Oranı % Sieving Rate
Depo Doldurma Ağız Süzgeci Tank Filler Opening Sieve	Dikdörtgen delikli Rectangular Perforated	Plastik Örgü Plastic Mesh	180	40
Depo Doldurucu Süzgeci Tank Filler Sieve	Kare delikli Square Perforated	Cr+Ni Tel örgü Cr+Ni Wire Mesh	256	33
Depo Çıkış Süzgeci Tank Output Sieve	Kare delikli Square Perforated	Cr+Ni Tel örgü Cr+Ni Wire Mesh	144	30
Malzeme Süzgeci Material Sieve	Kare delikli Square Perforated	Cr+Ni Tel örgü Cr+Ni Wire Mesh	576	56

## Nozullar Arası Mesafe / Distance Between Nozzles

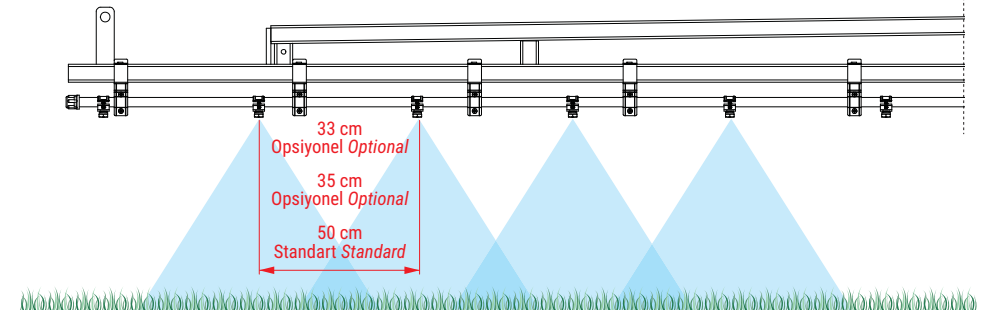

## Nozul İlaçlama Şekilleri / Nozzle Spraying Types

Konik Hüzme Nozul  
Chonic Brass Nozzle  
Plaket delik çapları  
Plate hole diameter  
0.8 mm  
1.0 mm  
1.2 mm  
1.5 mm  
2.0 mm

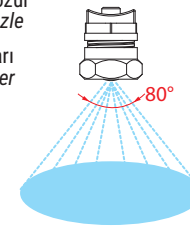

Yelpaze Hüzme Nozul  
Curtain Spray Nozzle

Plaket delik çapları  
Plate hole diameter  
110-01 110-04  
110-015 110-05  
110-02 110-06  
110-025 110-08  
110-03

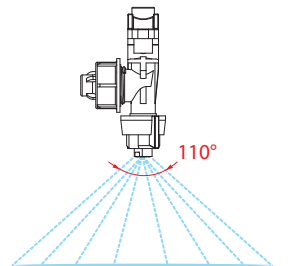

Ayarlanabilir Yükseklik  
Adjustable Height

max 125 cm  
min 50 cm

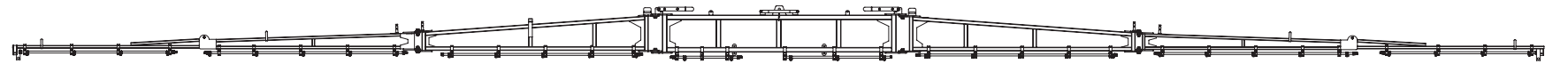

16 Metre Kol 16 m Boom / 156 kg / Nozul Dağılımı Nozzle Distribution : 4 5 5 5 5 4



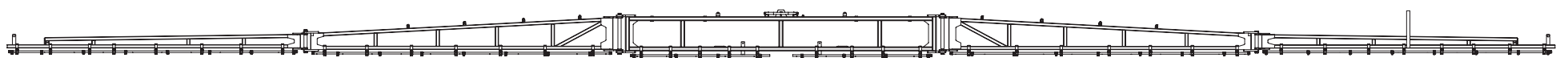

max 125 cm  
min 50 cm





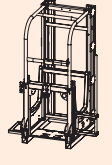
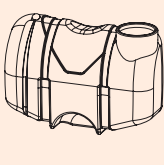
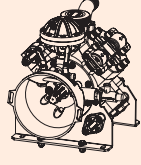
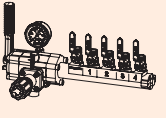

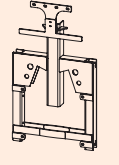
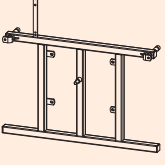

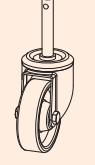
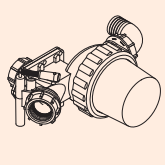
18 Metre Kol 18 m Boom / 265 kg / Nozul Dağılımı Nozzle Distribution : 8 7 7 7 8

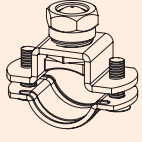
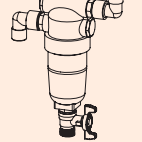

STANDART PARÇALAR  
STANDARD PARTS

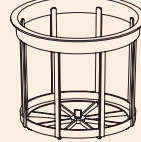
										
Şase	Polietilen depo	C145 Pompa	OPR 40-5 Kumanda	18 m Kol	Kızak	Beşik	Yükseklik Ayar Lifi	Teker	Filtre	
Double Chassis	Polyethylene tank	C145 Pump	OPR 40-5 Regulator	18 m Boom	Hydraulic Slide	Boom fasten frame	Height Adjustment Lift	Rotary Wheel	3 Way Filter	
Ürün Kodu Product Code	10300018	10003299 (TP 800) 10003300 (TP 1000)	10800004	11000004	10600013	10300006	10300011	10001519	10000290	10000355

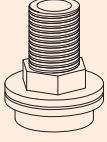

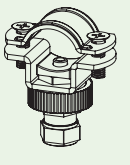
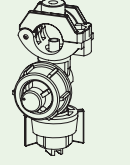
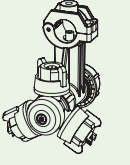
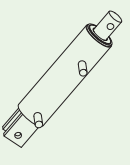
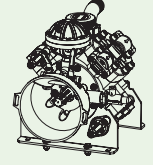
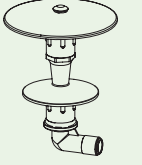
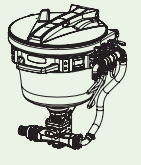
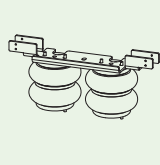

STANDART PARÇALAR  
STANDARD PARTS

									
Pirinç Nozul	Basınç Filtresi	Ayaklı Hortum Taşıyıcı	Kapak	Elek	El Yıkama Tank Kiti	Karıştırıcı Kiti	Hızlı Doldurucu Hortum Kiti	Şaft	
Brass Nozzle	Pressure Filter	Hose Conveyor with Pad	Cover	Sieve	Hand Washing Tank	Mixer	Fast Filling Hose	Shaft	
Ürün Kodu Product Code	10001355	10000103	10003753	10000385	10000407	12000052	12000017	12000051	10001214



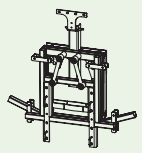

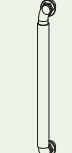
OPSIYONEL PARÇALAR  
OPTIONAL PARTS

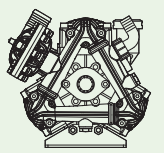
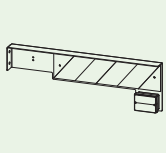
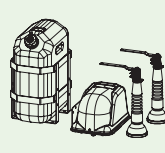
								
Tombul Nozul	Yelpaze Hüzmeleli Nozul	Üçlü Yelpaze Hüzmeleli Nozul	İlaçlama Denge Lifi	APS 145 Pompa	Toz İlaç Karıştırıcı	Mikser	Dikey Süspansiyon	
Conic Brass Nozzle	Single Curtain Spray Nozzle	Triple Curtain Spray Nozzle	Spraying Balance Lift	APS 145 Pump	Powder Chemical Mixer	Mixer	Vertical Gusseted Suspension	
Ürün Kodu Product Code	10000177	10000405	10000406	10000824	10000326	10003326	12000053	12000054

OPSIYONEL PARÇALAR  
OPTIONAL PARTS

							
Paralelogram Beşik	Tabanca Kiti	Göstergesi Kiti	Krom Boru	Düşük Basıncılı Pompa	Trafik Uyarı Seti	İz Belirleyici Kiti	
Paralelogram fasten frame	Spray Gun	Transparent Level Gauge	Chrome Pipe	Low Pressure Pump	Reverberator + Stop Light	Trace Marker	
Ürün Kodu Product Code	12000055	10002745	12000056	12000057	10800007	12000060	12000061

RENK SEÇENEKLERİ  
COLOR ALTERNATIVES

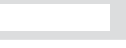
1	2	3			
Şase Chasis	Depo Storage	Şase Chasis	Depo Storage	Şase Chasis	Depo Storage
					
Yeşil Green	Turuncu Orange	Siyah Black	Kırmızı Red	Galvaniz Galvanized	Beyaz White