

ALFA XTP 1000

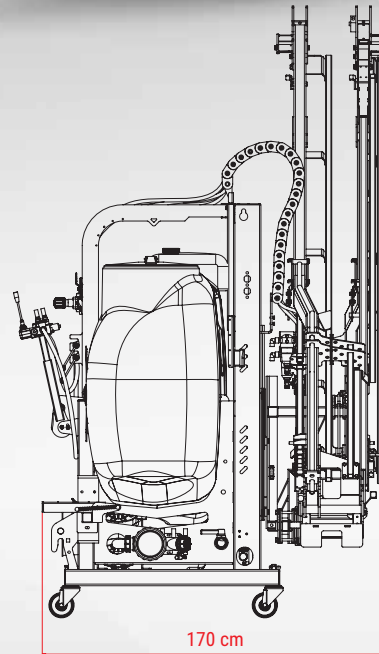

Yükleme Adetleri / Loading Pcs

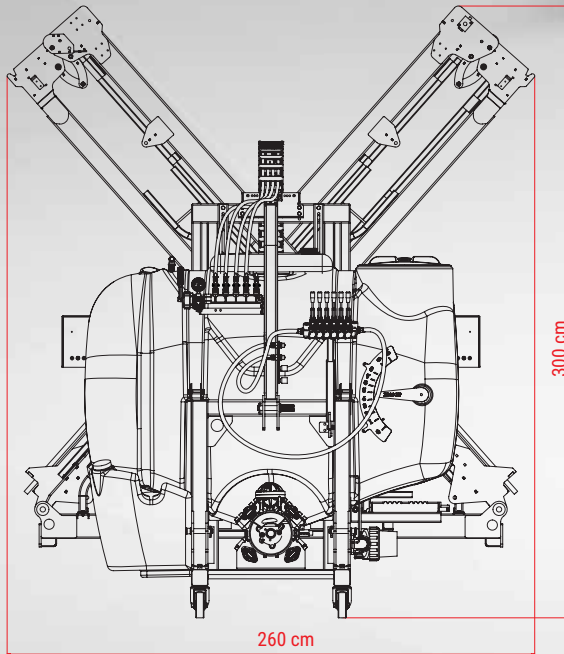

3



6



0



6

Teknik Özellikler / Technical Specifications

Pompa Modeli <i>Pump</i>	Piston membranlı <i>Piston diaphragm</i>	Önallar C145
Pompa Debisi <i>Pump Flowrate</i>	l/dk <i>l/min</i>	145
Pompa Basıncı <i>Pump Pressure</i>	Bar	50
Kontrol Paneli <i>Control Panel</i>		OPR 40-5
İş Geniřlięi <i>Working Width</i>	m	18
Nozul Tipi <i>Nozzle</i>		Konik hüzmeli pirinç <i>Conic beamed and clamped</i>
Nozul Sayısı <i>Nr. Of Nozzle</i>		37
Nozullar Arası Mesafe <i>The Distance Between Nozzle</i>	cm	50
İlaçlama Kolu Yükseklięi Ayarı <i>Boom Height Adjustment</i>		Hidrolik <i>Hydraulic</i>
İlaçlama Kolu Katlanması <i>Boom Opening Adjustment</i>		Manuel <i>Manual</i>
Gereken Traktör Gücü <i>Required Power</i>	BG <i>HP</i>	70-90
Çalışma Devri <i>Speed</i>	dev/dk <i>RPM</i>	540
Ağırlık <i>Weight</i>	kg	

Basıncı suyu süzerek
ilaçlama verimini yükseltir.

*Productivity by filtering
pressured water.*



Ana depodan bağımsız
el yıkama tankı temiz
su ihtiyacını karşılar.

*Hand washing tank
apart from main tank
supplies clean water.*

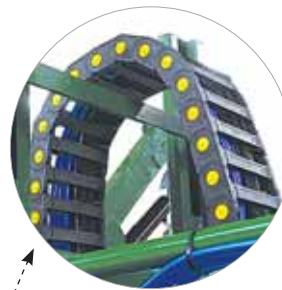

Kumanda ve kol arasındaki
hortumların düzenli
olmasına yarar.

*Cable canals support the
hoses between regulator
and boom against dam.*



Homojen ve hassas
ilaçlama normu sağlar.

*Homogeneous and
sensitive disinfection.*



Hidrolik liflerin uzaktan
kontrolünü sağlar.

*Provides the distant
control of hydraulic lifts.*

Araziye göre
kolun eğimini
ayarlar.

*Adjusts the
pitch of boom
according to terrain
condition.*



Kolun hidrolik kumanda
ile kolayca açılıp
kapanmasını sağlar.

*Provides to work easier
the boom by the help of
hydraulic regulator.*



Uzun ömürlü ve
temizlenebilir nozul
homojen ilaçlama
yapar.

*Long-lasting and
cleanable nozzle
provides homogeneous
disinfection.*



Depo yıkama sistemi.
Tank cleaning system.



Dikey körüklü süspansiyon
salınımı minimuma indirir.

*Vertical bellow suspensions
minimize the vibration.*



Dökümünden montajına kadar kendi
imalatımız 4 membranlı C145 pompa
sınıfında en iyi performansa sahiptir.

*The best quality 4 membrane C145 pump
which is manufactured by our factory is
the most efficient product of its segment.*



Depoda kalan su miktarını
hassas ölçen şamandıralı
gösterge.

*Sensitive float indicator
which quantifies of residual
water in the tank.*

Temizlenebilir filtre
ilaçlamanın sağlıklı
yapılabilmesini sağlar.

*Cleanable filter enables
homogenous spraying.*

İlaçlama sonrasında depoda
kalan suyun tahliyesini hızlı bir
şekilde gerçekleştirir.

*Fast removing of remained water
on the tank after disinfection.*



ALFA XTP

C145 Pompa Randıman Değerleri / C145 Pump Productivity Rates

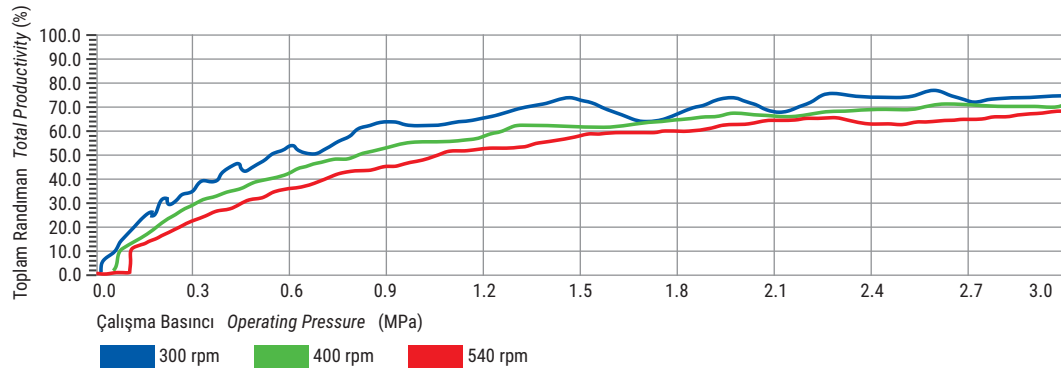

C145 Pompa Verdi Değerleri / C145 Pump Flowrate Rates

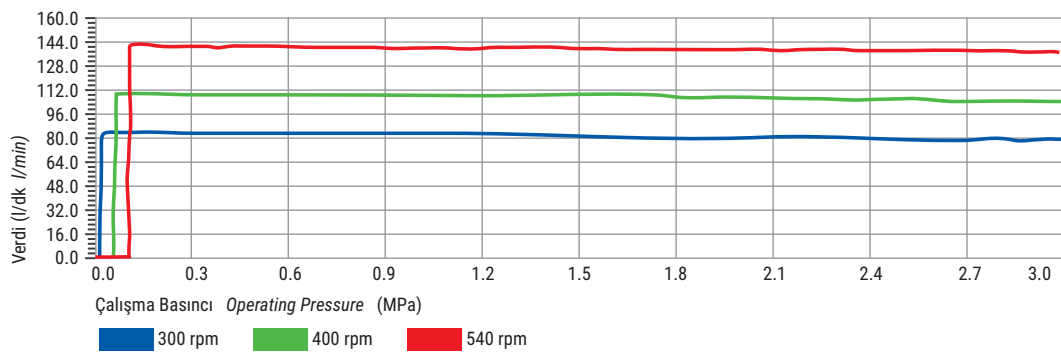

Makine Çalışma Sistemi / Machine Working Principle

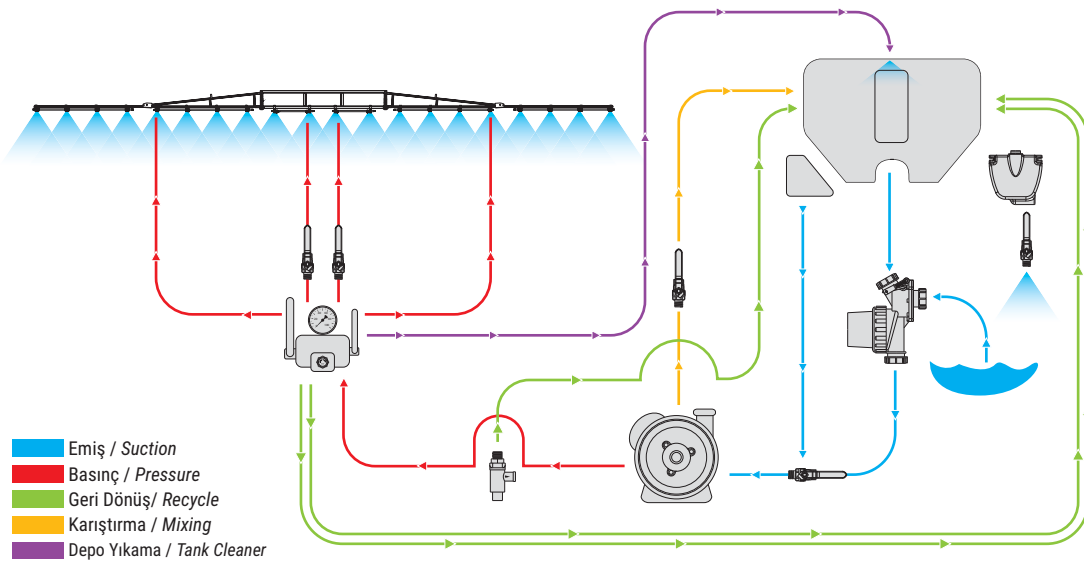

Ayarlanabilir Yükseklik
Adjustable Height

max 125 cm
min 50 cm

12 Metre Kol 12 m Boom / Nozul Dağılımı Nozzle Distribution : 4 6 4 6 4

max 125 cm
min 50 cm

15 Metre Kol 15 m Boom / Nozul Dağılımı Nozzle Distribution : 5 7 4 7 5

max 125 cm
min 50 cm

18 Metre Kol 18 m Boom / Nozul Dağılımı Nozzle Distribution : 4 5 6 5 5 6 5 4

Ürünlerimizde teknoloji ve çalışma şartlarına bağlı olarak değişiklik yapma hakkımız saklıdır.
Onallar has the right to make changes to manufacturing in the products.

Depo Doldurucusu Test Sonuçları / Test Results Of Filter

Hidrolik tip venturi depo doldurucusunun;
Alfa YXTP 1000 : 11 dk 1 sn'de
3 mpa basınçta 540 devirde doldurduğu tespit edilmiştir.

It is determined that hydraulic type venturi tank filler fills the
Alfa YXTP 1000 : 11 min. 1 sec.
under operating at 3.0 MPa and 540 rpm cycle.

Bu değerler test ortamında elde edilmiş olup,
şartlara bağlı olarak değişiklik gösterebilir.

These values are obtained in the test environment
and may vary depending on the conditions.

Hortum Test Sonuçları / Test Results Of Hose

Makinada bulunan hortumların, hortum deney standında çalışma basıncının 3 katı statik basınç altında (9.0 MPa) deforme olmadığı, çap ve form değişikliğine uğramadığı tespit edilmiştir.

Any deformation is not detected on the hoses which are used on the machine, in spite of practicing pressure over three times (9.0 MPa) than operating pressure.

Süzgeçler / Sieves

Kullanım Yeri Place Of Use	Tipi Type	Malzeme Material Type	Delik Sayısı adet/cm ² Hole Quantity pcs/cm ²	Süzme Oranı % Sieving Rate
Depo Doldurma Ağız Süzgeci Tank Filler Opening Sieve	Dikdörtgen delikli Rectangular Perforated	Plastik Örgü Plastic Mesh	180	40
Depo Doldurucu Süzgeci Tank Filler Sieve	Kare delikli Square Perforated	Cr+Ni Tel örgü Cr+Ni Wire Mesh	256	33
Depo Çıkış Süzgeci Tank Output Sieve	Kare delikli Square Perforated	Cr+Ni Tel örgü Cr+Ni Wire Mesh	144	30
Malzeme Süzgeci Material Sieve	Kare delikli Square Perforated	Cr+Ni Tel örgü Cr+Ni Wire Mesh	576	56

Nozullar Arası Mesafe / Distance Between Nozzles

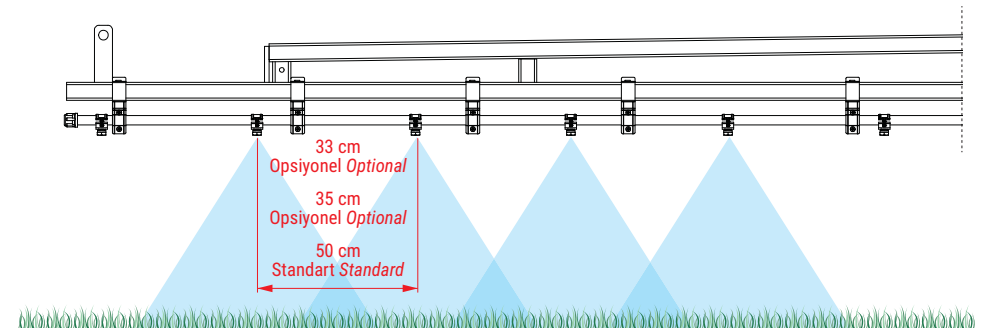

Nozul İlaçlama Şekilleri / Nozzle Spraying Types

Konik Hüzme Nozul
Chonic Brass Nozzle

Plaket delik çapları
Plate hole diameter
0.8 mm
1.0 mm
1.2 mm
1.5 mm
2.0 mm

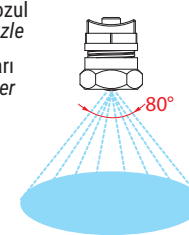

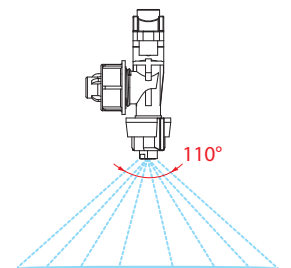

Yelpaze Hüzme Nozul
Curtain Spray Nozzle

Plaket delik çapları
Plate hole diameter
110-01 110-04
110-015 110-05
110-02 110-06
110-025 110-08
110-03





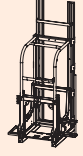
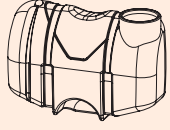
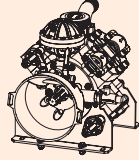
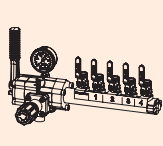
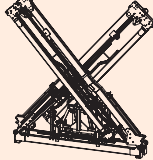
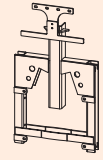
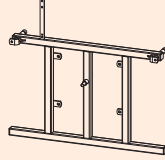

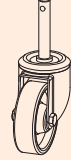
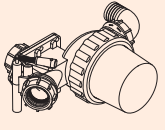
Nozul aralığı ve sayısı isteğe göre değişebilir.
Adjustable nozzle quantity and gap as optional.

STANDART PARÇALAR
STANDARD PARTS

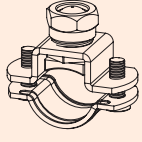
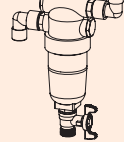
										
Şase Double Chassis	Polietilen depo Polyethylene tank	C145 Pompa C145 Pump	OPR 40-5 Kumanda OPR 40-5 Regulator	18 m "X" Kol 18 m "X" Boom	Kızak Hydraulic Slide	Beşik Boom fasten frame	Yükseklik Ayar Lifi Height Adjustment Lift	Teker Rotary Wheel	Filtre 3 Way Filter	
Ürün Kodu Product Code	10300019	10003299 (YTP 800) 10003300 (YTP 1000)	10800004	11000004	10600016	10300006	10300011	10000154	10000290	10000355

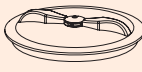
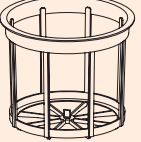
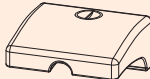
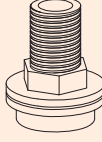

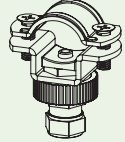
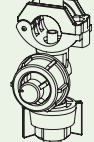
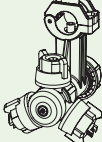
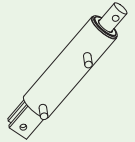
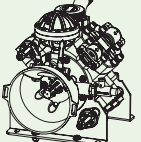
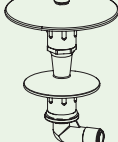
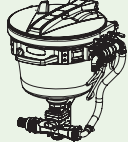
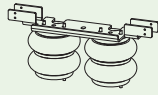

STANDART PARÇALAR
STANDARD PARTS

									
Pirinç Nozul Brass Nozzle	Basınç Filtresi Pressure Filter	Ayaklı Hortum Taşıyıcı Hose Conveyor with Pad	Kapak Cover	Elek Sieve	El Yıkama Tank Kiti Hand Washing Tank	Karıştırıcı Kiti Mixer	Hızlı Doldurucu Hortum Kiti Fast Filling Hose	Şaft Shaft	
Ürün Kodu Product Code	10001355	10000103	10003754	10000385	10000407	12000052	12000017	12000051	10001214



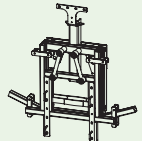

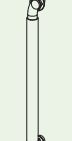
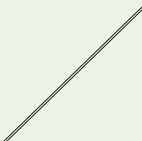
OPSİYONEL PARÇALAR
OPTIONAL PARTS

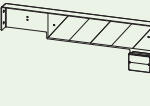
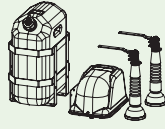
								
Tombul Nozul Conic Brass Nozzle	Yelpaze Hüzmesi Nozul Single Curtain Spray Nozzle	Üçlü Yelpaze Hüzmesi Nozul Triple Curtain Spray Nozzle	İlaçlama Denge Lifi Spraying Balance Lift	APS 145 Pompa APS 145 Pump	Toz İlaç Karıştırıcı Powder Chemical Mixer	Mikser Mixer	Dikey Süspansiyon Vertical Gusseted Suspension	
Ürün Kodu Product Code	10000177	10000405	10000406	10000824	10000326	10003326	12000053	12000054

OPSİYONEL PARÇALAR
OPTIONAL PARTS

							
Paralelogram Beşik Paralelogram fasten frame	Tabanca Kiti Spray Gun	Göstergesi Kiti Transparent Level Gauge	Krom Boru Chrome Pipe	Düşük Basıncılı Pompa Low Pressure Pump	Trafik Uyarı Seti Reverberator + Stop Light	İz Belirleyici Kiti Trace Marker	
Ürün Kodu Product Code	12000055	10002745	12000056	12000057	10800007	12000060	12000061

RENK SEÇENEKLERİ
COLOR ALTERNATIVES

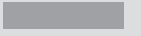
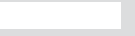
1	2	3			
Şase Chasis	Depo Storage	Şase Chasis	Depo Storage	Şase Chasis	Depo Storage
					
Yeşil Green	Turuncu Orange	Siyah Black	Kırmızı Red	Galvaniz Galvanized	Beyaz White