

# ALFA YTP 800



Kaynak Robot  
Welding Robot



Toz Boya  
Powder Paint



Test Edilmiştir  
Tested



2 Yıl Garanti  
2 Years Warranty

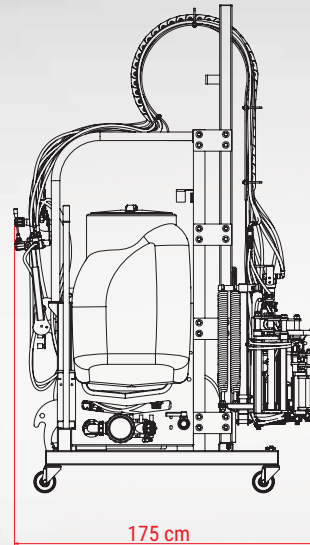
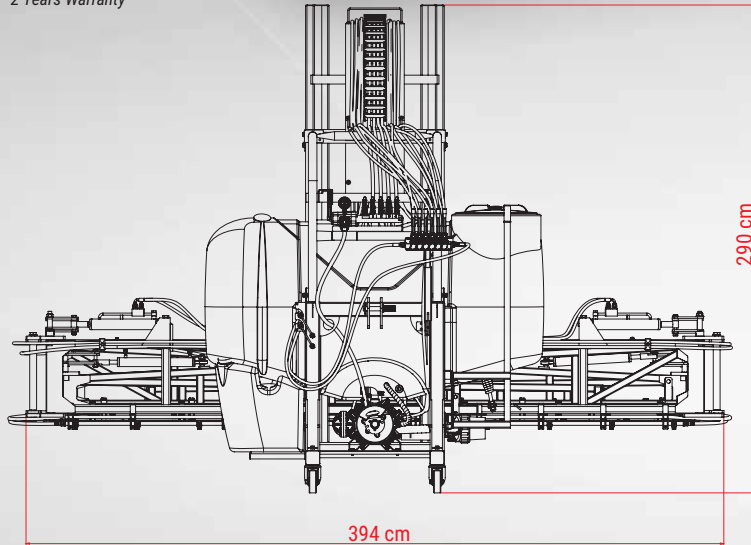

### Yükleme Adetleri / Loading Pcs



3



6



3



9

### Teknik Özellikler / Technical Specifications

|  |                                      |   |
|--|--------------------------------------|---|
| Pompa Modeli<br>Pump                                     | Piston membranlı<br>Piston diaphragm | Önallar C145                                    |
| Pompa Debisi<br>Pump Flowrate                            | l/dk<br>l/min                        | 145   |
| Pompa Basıncı<br>Pump Pressure                           | Bar                                  | 50  |
| Kontrol Paneli<br>Control Panel                          |                                      | OPR 40-5  |
| İş Genişliği<br>Working Width                            | m                                    | 18  |
| Nozul Tipi<br>Nozzle                                     |                                      | Konik hüzmeli piriç<br>Conic beamed and clamped |
| Nozul Sayısı<br>Nr. Of Nozzle                            |                                      | 37  |
| Nozullar Arası Mesafe<br>The Distance Between Nozzle     | cm                                   | 50  |
| İlaçlama Kolu Yüksekliği Ayarı<br>Boom Height Adjustment |                                      | Hidrolik<br>Hydraulic                           |
| İlaçlama Kolu Katlanması<br>Boom Opening Adjustment      |                                      | Manuel<br>Manual                                |
| Gerekten Traktör Gücü<br>Required Power                  | BG<br>HP                             | 70-90   |
| Çalışma Devri<br>Speed                                   | dev/dk<br>RPM                        | 540   |
| Ağırlık<br>Weight  | kg                                   | 873   |

Basınçlı suyu süzerek  
ilaçlama verimini yükseltir.

*Productivity by filtering  
pressured water.*



Ana depodan bağımsız  
el yıkama tankı temiz  
su ihtiyacını karşılar.

*Hand washing tank  
apart from main tank  
supplies clean water.*



Kumanda ve kol arasındaki  
hortumların düzenli  
olmasına yarar.

*Cable canals support the  
hoses between regulator  
and boom against dam.*



Homojen ve hassas  
ilaçlama normu sağlar.

*Homogeneous and  
sensitive disinfection.*



Hidrolik liflerin uzaktan  
kontrolünü sağlar.

*Provides the distant  
control of hydraulic lifts.*



Depo Kapağı

*Tank Lid*



Depoda kalan su miktarını  
hassas ölçen şamandıralı  
gösterge.

*Sensitive float indicator  
which quantifies of residual  
water in the tank.*



Temizlenebilir filtre  
ilaçlamanın sağlıklı  
yapılabilmesini sağlar.

*Cleanable filter enables  
homogenous spraying.*



İlaçlama sonrasında depoda  
kalan suyun tahliyesini hızlı bir  
şekilde gerçekleştirir.

*Fast removing of remained water  
on the tank after disinfection.*



Dökümünden montajına kadar kendi  
imalatımız 4 membranlı C145 pompa  
sınıfında en iyi performansa sahiptir.

*The best quality 4 membrane C145 pump  
which is manufactured by our factory is  
the most efficient product of its segment.*



Depo yıkama sistemi.

*Tank cleaning system.*



Uzun ömürlü ve  
temizlenebilir nozul  
homojen ilaçlama yapar.

*Long-lasting and  
cleanable nozzle provides  
homogeneous disinfection.*



Kolun hidrolik  
kumanda ile kolayca  
açılıp kapanmasını  
sağlar.

*Provides to work  
easier the boom by  
the help of hydraulic  
regulator.*

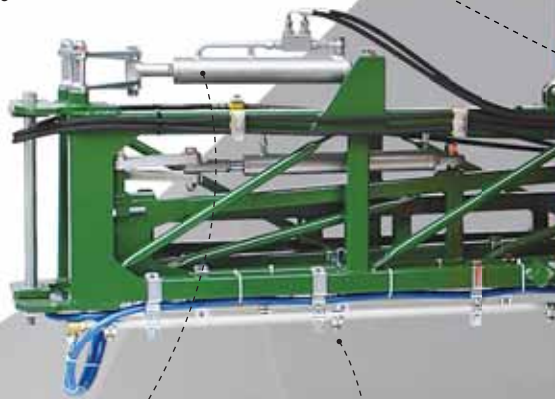

Araziye göre kolun  
eğimini ayarlar.

*Adjusts the pitch of  
boom according to  
terrain condition.*



Makinenin trafikte  
farkedilmesini sağlar.

*Enables to be easily  
noticeable in the traffic  
machine.*





# ALFA YTP

## C145 Pompa Randıman Değerleri / C145 Pump Productivity Rates

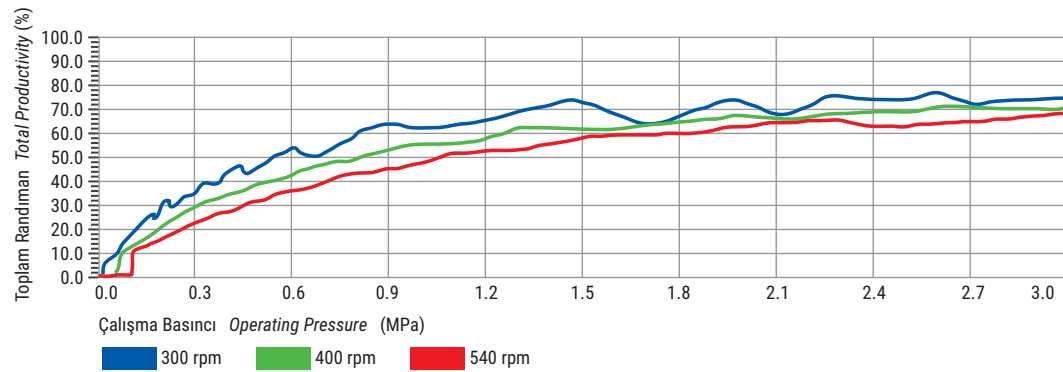

## C145 Pompa Verdi Değerleri / C145 Pump Flowrate Rates

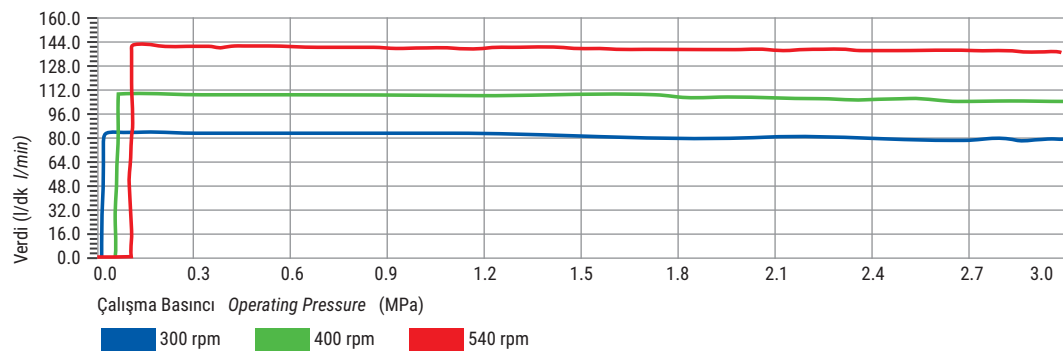

## Makine Çalışma Sistemi / Machine Working Principle

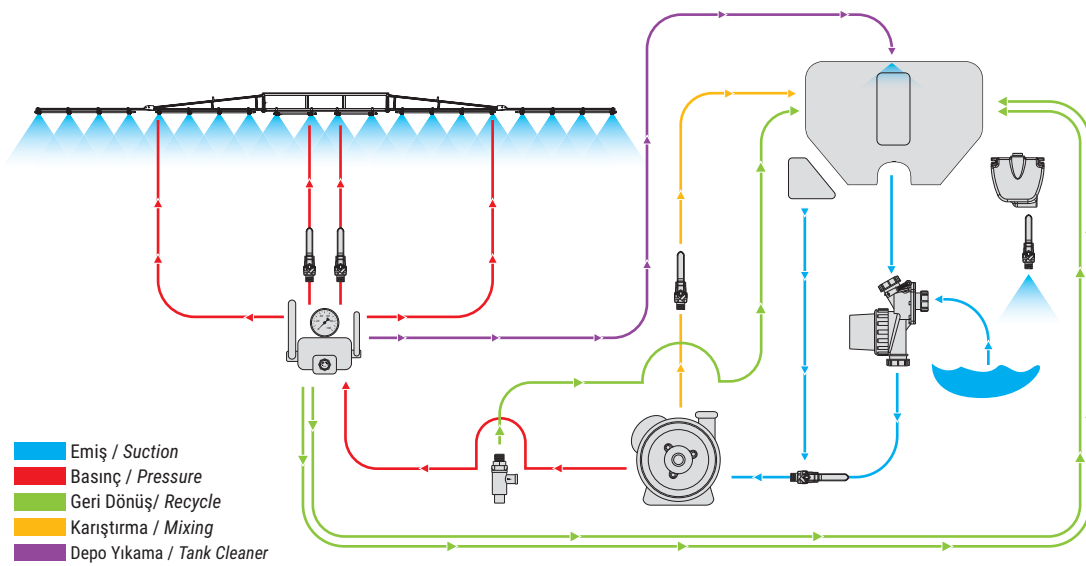

Ayarlanabilir Yükseklik  
Adjustable Height

max 125 cm  
min 50 cm

16 Metre Kol 16 m Boom / 156 kg / Nozul Dağılımı Nozzle Distribution : 4 5 5 5 5 4

max 125 cm  
min 50 cm

18 Metre Kol 18 m Boom / 265 kg / Nozul Dağılımı Nozzle Distribution : 8 7 7 7 8

Ürünlerimizde teknoloji ve çalışma şartlarına bağlı olarak değişiklik yapma hakkımız saklıdır.  
Onallar has the right to make changes to manufacturing in the products.

## Depo Doldurucusu Test Sonuçları / Test Results Of Filter

Hidrolik tip venturi depo doldurucusunun;  
Alfa YTP 800 : 9 dk 2 sn  
Alfa YTP 1000 : 11 dk 1 sn'de  
3 mpa basınçta 540 devirde doldurduğu tespit edilmiştir.

It is determined that hydraulic type venturi tank filler fills the  
Alfa YTP 800 : 9 min. 2 sec.  
Alfa YTP 1000 : 11 min. 1 sec.  
under operating at 3.0 MPa and 540 rpm cycle.

Bu değerler test ortamında elde edilmiş olup,  
şartlara bağlı olarak değişkenlik gösterebilir.

These values are obtained in the test environment  
and may vary depending on the conditions.

## Hortum Test Sonuçları / Test Results Of Hose

Makinada bulunan hortumların, hortum deney standında çalışma basıncının 3 katı statik basınç altında (9.0 MPa) deforme olmadığı, çap ve form değişikliğine uğramadığı tespit edilmiştir.

Any deformation is not detected on the hoses which are used on the machine, in spite of practicing pressure over three times (9.0 MPa) than operating pressure.

## Süzgeçler / Sieves

| Kullanım Yeri<br>Place Of Use                              | Tipi<br>Type                                 | Malzeme<br>Material Type          | Delik Sayısı adet/cm <sup>2</sup><br>Hole Quantity pcs/cm <sup>2</sup> | Süzme Oranı %<br>Sieving Rate |
|--|--|-----------------------------------|--|-------------------------------|
| Depo Doldurma<br>Ağız Süzgeci<br>Tank Filler Opening Sieve | Dikdörtgen delikli<br>Rectangular Perforated | Plastik Örgü<br>Plastic Mesh      | 180  | 40                            |
| Depo Doldurucu Süzgeci<br>Tank Filler Sieve                | Kare delikli<br>Square Perforated            | Cr+Ni Tel örgü<br>Cr+Ni Wire Mesh | 256  | 33                            |
| Depo Çıkış Süzgeci<br>Tank Output Sieve                    | Kare delikli<br>Square Perforated            | Cr+Ni Tel örgü<br>Cr+Ni Wire Mesh | 144  | 30                            |
| Malzeme Süzgeci<br>Material Sieve                          | Kare delikli<br>Square Perforated            | Cr+Ni Tel örgü<br>Cr+Ni Wire Mesh | 576  | 56                            |

## Nozullar Arası Mesafe / Distance Between Nozzles

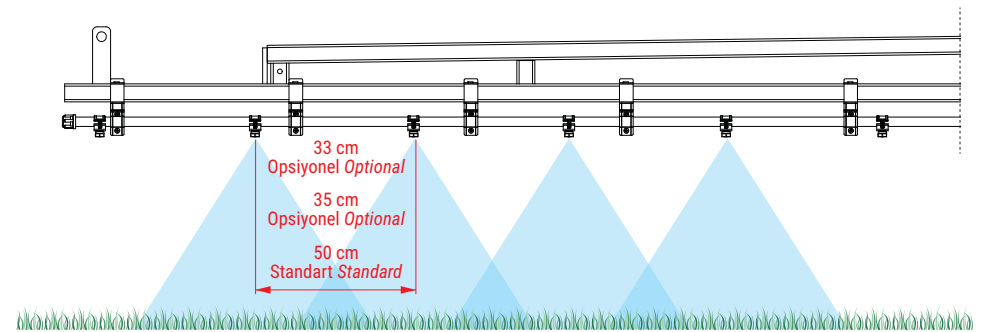

## Nozul İlaçlama Şekilleri / Nozzle Spraying Types

Konik Hüzme Nozul  
Chonic Brass Nozzle

Plaket delik çapları  
Plate hole diameter  
0.8 mm  
1.0 mm  
1.2 mm  
1.5 mm  
2.0 mm

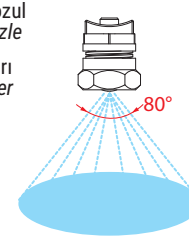



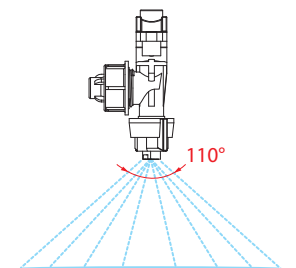

Yelpaze Hüzme Nozul  
Curtain Spray Nozzle

Plaket delik çapları  
Plate hole diameter  
110-01 110-04  
110-015 110-05  
110-02 110-06  
110-025 110-08  
110-03



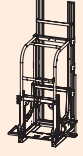
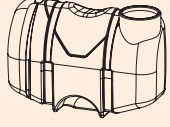
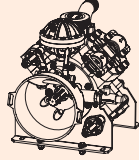
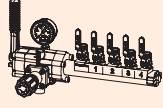

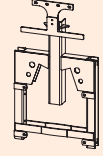
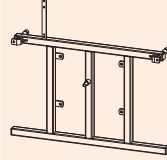

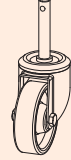
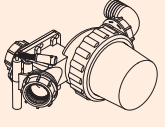
Nozul aralığı ve sayısı isteğe göre değişebilir.  
Adjustable nozzle quantity and gap as optional.

STANDART PARÇALAR  
STANDARD PARTS

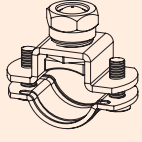
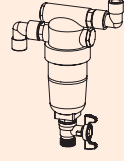
|   |   |   |  |   |   |   |   |   |   |          |
|---|---|---|--|---|---|---|---|---|---|----------|
|  |  |  |  |  |  |  |  |  |  |          |
| Şase  | Polietilen depo   | C145 Pompa  | OPR 40-5 Kumanda   | 18 m Kol  | Kızak   | Beşik   | Yükseklik Ayar Lifi   | Teker   | Filtre  |          |
| Double Chassis  | Polyethylene tank   | C145 Pump   | OPR 40-5 Regulator   | 18 m Boom   | Hydraulic Slide   | Boom fasten frame   | Height Adjustment Lift  | Rotary Wheel  | 3 Way Filter  |          |
| Ürün Kodu<br>Product Code   | 10300019  | 10003299 (YTP 800)<br>10003300 (YTP 1000)   | 10800004   | 11000004  | 10600013  | 10300006  | 10300011  | 10000154  | 10000290  | 10000355 |

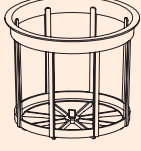
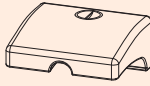
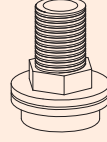

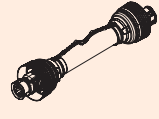

STANDART PARÇALAR  
STANDARD PARTS

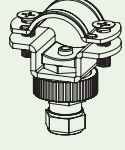
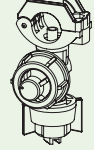
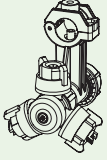
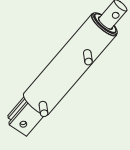
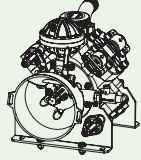
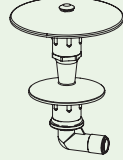
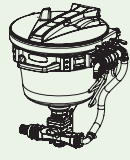
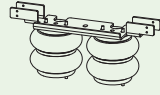
|   |   |   |  |   |   |   |   |   |          |
|---|---|---|--|---|---|---|---|---|----------|
|  |  |  |  |  |  |  |  |  |          |
| Pirinç Nozul  | Basınç Filtresi   | Ayaklı Hortum Taşıyıcı  | Kapak  | Elek  | El Yıkama Tank Kiti   | Karıştırıcı Kiti  | Hızlı Doldurucu Hortum Kiti   | Şaft  |          |
| Brass Nozzle  | Pressure Filter   | Hose Conveyor with Pad  | Cover  | Sieve   | Hand Washing Tank   | Mixer   | Fast Filling Hose   | Shaft   |          |
| Ürün Kodu<br>Product Code   | 10001355  | 10000103  | 10003754   | 10000385  | 10000407  | 12000052  | 12000017  | 12000051  | 10001214 |



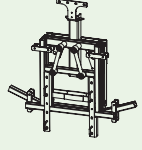

OPSİYONEL PARÇALAR  
OPTIONAL PARTS

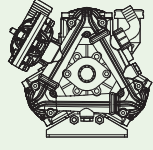
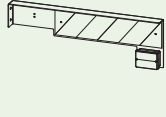
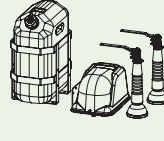
|   |   |   |  |   |   |   |   |
|---|---|---|--|---|---|---|---|
|  |  |  |  |  |  |  |  |
| Tombul Nozul  | Yelpaze Hüzmesi Nozul   | Üçlü Yelpaze Hüzmesi Nozul  | İlaçlama Denge Lifi  | APS 145 Pompa   | Toz İlaç Karıştırıcı  | Mikser  | Dikey Süspansiyon   |
| Conic Brass Nozzle  | Single Curtain Spray Nozzle   | Triple Curtain Spray Nozzle   | Spraying Balance Lift  | APS 145 Pump  | Powder Chemical Mixer   | Mixer   | Vertical Gusseted Suspension  |
| Ürün Kodu<br>Product Code   | 10000177  | 10000405  | 10000824   | 10000326  | 10003326  | 12000053  | 12000054  |

OPSİYONEL PARÇALAR  
OPTIONAL PARTS

|   |   |   |  |   |   |   |          |
|---|---|---|--|---|---|---|----------|
|  |  |  |  |  |  |  |          |
| Paralelogram Beşik  | Tabanca Kiti  | Göstergesi Kiti   | Krom Boru  | Düşük Basıncılı Pompa   | Trafik Uyarı Seti   | İz Belirleyici Kiti   |          |
| Paralelogram fasten frame   | Spray Gun   | Transparent Level Gauge   | Chrome Pipe  | Low Pressure Pump   | Reverberator + Stop Light   | Trace Marker  |          |
| Ürün Kodu<br>Product Code   | 12000055  | 10002745  | 12000056   | 12000057  | 10800007  | 12000060  | 12000061 |

RENK SEÇENEKLERİ  
COLOR ALTERNATIVES

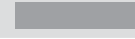
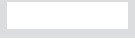
|   |   |   |  |   |   |
|---|---|---|--|---|---|
| 1   | 2   | 3   |  |   |   |
| Şase Chasis   | Depo Storage  | Şase Chasis   | Depo Storage   | Şase Chasis   | Depo Storage  |
|  |  |  |  |  |  |
| Yeşil<br>Green  | Turuncu<br>Orange   | Siyah<br>Black  | Kırmızı<br>Red   | Galvaniz<br>Galvanized  | Beyaz<br>White  |