



FABLE SNP S 1000



Kaynak Robot
Welding Robot



Toz Boya
Powder Paint



Test Edilmiştir
Tested



2 Yıl Garanti
2 Years Warranty

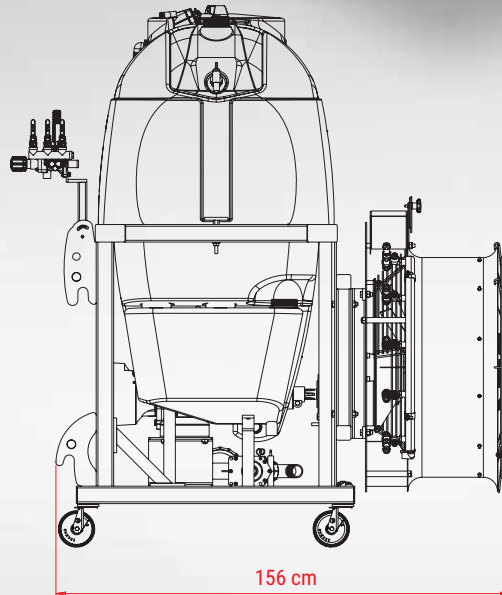
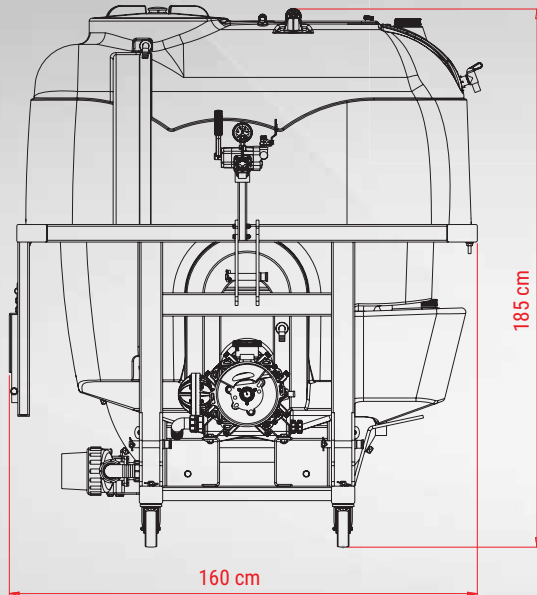

Yükleme Adetleri / Loading Pcs



6



10



10



24

Teknik Özellikler / Technical Specifications

Pompa Modeli Pump	Piston membranlı Piston diaphragm	Önallar C96
Pompa Debisi Pump Flowrate	l/dk l/min	96
Pompa Basıncı Pump Pressure	Bar	50
Kontrol Paneli Control Panel		OPR 40-3
Nozul Tipi Nozzle		Pirinç stoperli atomizör Atomizer brass with stopper
Nozul Sayısı Nr. Of Nozzle		5+5
Fan Çapı Fan Diameter	cm	75
İş Genişliği Working Width	cm	12 - 16
Gereken Traktör Gücü Required Power	BG HP	50
Çalışma Devri Speed	dev/dk RPM	540
Hava Debisi Air Flowrate	m ³ /h	54000
Ağırlık Weight	kg	339



Çalışma esnasında yönlendirmeyi sağlayan kapaklar.
Provide the routing while operating.



Oluşabilecek kazalara karşı önlem amaçlı fan koruma teli.
Fan protection string for prevention against accidents.



Açısı ayarlanabilir atomizör nozulu.
Angle adjustable atomizer nozzle.



Kapağa erişimi kolay hale getiren merdiven.
The stair which provides to access through the cover easier.



Depo Kapağı
Tank Lid



Hızlı Doldurucu
Fast Filler



Ana depodan bağımsız el yıkama tankı temiz su ihtiyacını karşılar.
Hand washing tank apart from main tank supplies clean water.



Hız ayarlı şanzıman ünitesi
Speed adjustable gearbox unit



Homojen ve hassas ilaçlama normu sağlar.
Homogeneous and Sensitive Disinfection.



Depo yıkama sistemi.
Tank cleaning system.



Temizlenebilir filtre ilaçlamanın sağlıklı yapılabilmesini sağlar.
Cleanable filter enables homogenous spraying



Dökümünden montajına kadar kendi imalatımız 4 membranlı C96 pompa sınıfında en iyi performansa sahiptir.
The best quality 4 membrane C96 pump which is manufactured by our factory is the most efficient product of its segment.



FABLE SNP S

C96 Pompa Randıman Değerleri / C96 Pump Productivity Rates

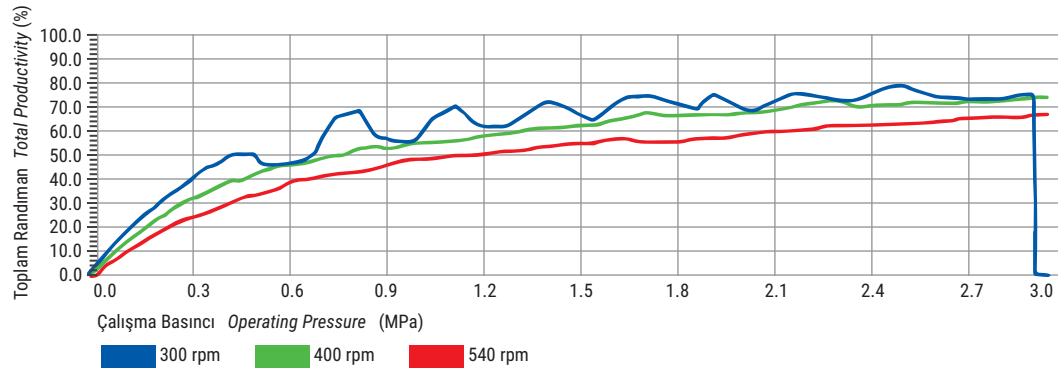

C96 Pompa Verdi Değerleri / C96 Pump Flowrate Rates

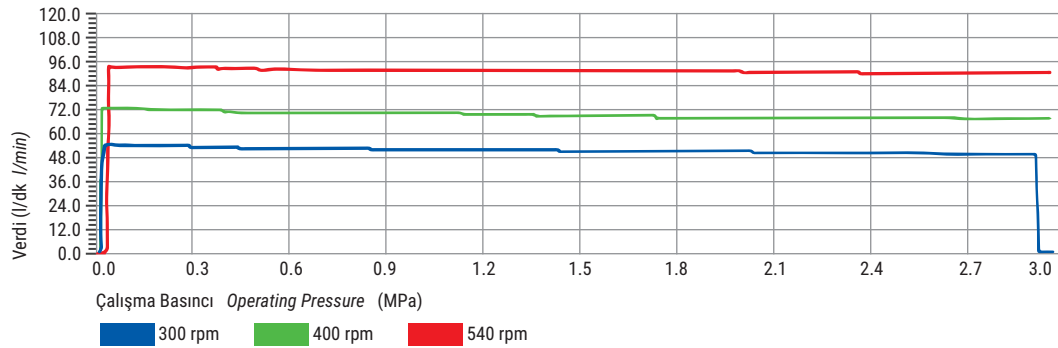

Makine Çalışma Sistemi / Machine Working Principle

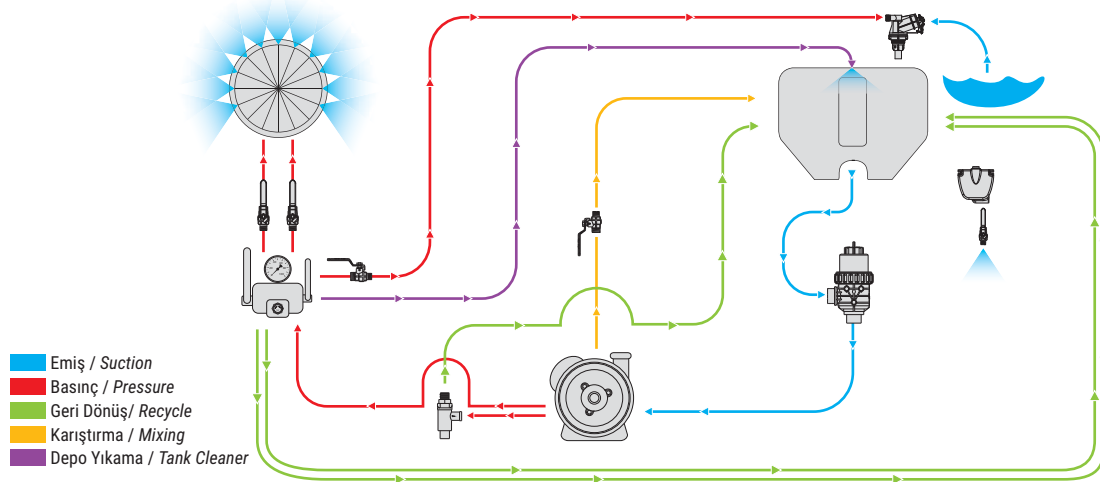

Depo Doldurucu Test Sonuçları / Test Results Of Filter

Hidrolik tip venturi depo doldurucusunun;
Fable SNPS 600 : 6 dk 17 sn
Fable SNPS 800 : 8 dk 22 sn
Fable SNPS 1000 : 10 dk 28 sn'de
3 mpa basınçta 540 devirde doldurduğu tespit edilmiştir.

It is determined that hydraulic type venturi tank filler fills the
Fable SNPS 600 : 6 min. 17 sec.
Fable SNPS 800 : 8 min. 22 sec.
Fable SNPS 1000 : 10 min. 28 sec.
under operating at 3.0 MPa and 540 rpm cycle.

Bu değerler test ortamında elde edilmiş olup,
şartlara bağlı olarak değişiklik gösterebilir.

These values are obtained in the test environment
and may vary depending on the conditions.

Hortum Test Sonuçları / Test Results Of Hose

Makinede bulunan hortumların, hortum deney standında çalışma basıncının 3 katı statik basınç altında (9.0 MPa) deforme olmadığı, çap ve form değişikliğine uğramadığı tespit edilmiştir.

Any deformation is not detected on the hoses which are used on the machine, in spite of practicing pressure over three times (9.0 MPa) than operating pressure.

Süzgeçler / Sieves

Kullanım Yeri Place Of Use	Tipi Type	Malzeme Material Type	Delik Sayısı adet/cm ² Hole Quantity pcs/cm ²	Süzme Oranı % Sieving Rate
Depo Doldurma Ağız Süzgeci Tank Filler Opening Sieve	Dikdörtgen delikli Rectangular Perforated	Plastik Örgü Plastic Mesh	180	40
Depo Doldurucu Süzgeci Tank Filler Sieve	Kare delikli Square Perforated	Cr+Ni Tel örgü Cr+Ni Wire Mesh	256	33
Depo Çıkış Süzgeci Tank Output Sieve	Kare delikli Square Perforated	Cr+Ni Tel örgü Cr+Ni Wire Mesh	144	30
Malzeme Süzgeci Material Sieve	Kare delikli Square Perforated	Cr+Ni Tel örgü Cr+Ni Wire Mesh	576	56

Nozul İlaçlama Şekilleri / Nozzle Spraying Types

Hunili Nozul
Funnel Nozzle

Plaket delik çapları
Plate hole diameter
0.8 mm
1.0 mm
1.2 mm
1.5 mm
1.8 mm

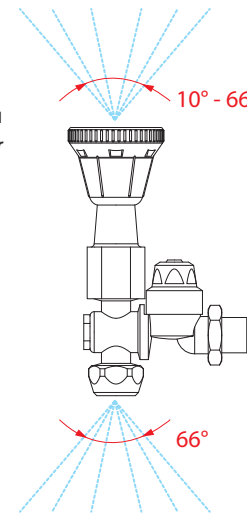

İthal Nozul
Importation Nozzle

Plaket delik çapları
Plate hole diameter
0.8 mm
1.0 mm
1.2 mm
1.5 mm
1.8 mm

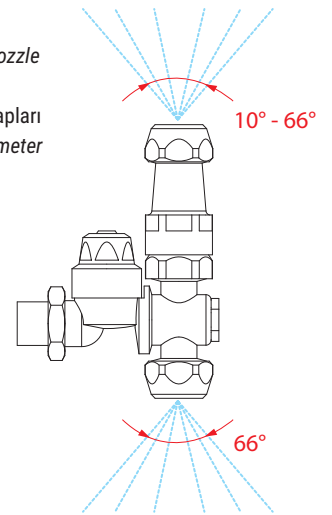



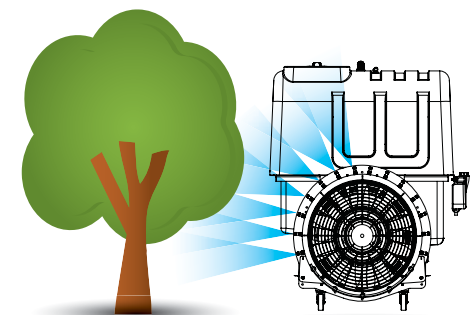
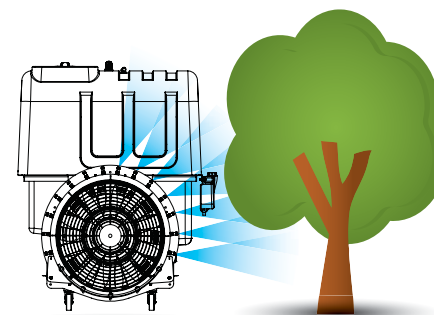
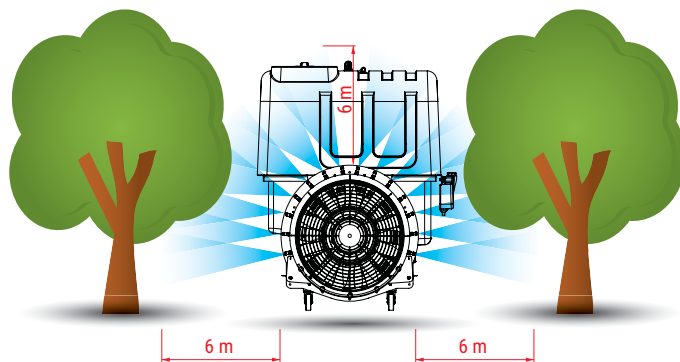

Makine İlaçlama Şekilleri / Machine Spraying Types

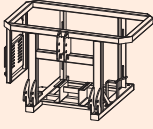
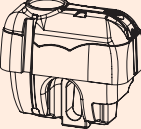
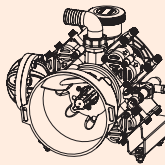
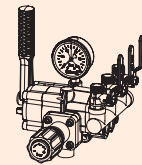
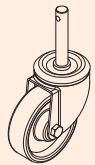
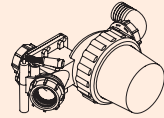
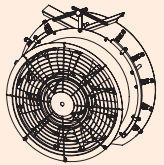

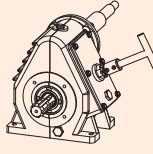

STANDART PARÇALAR
STANDARD PARTS

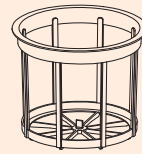
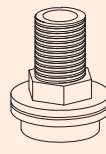
							
Parça Adı Product Name	Şase Chassis	Polietilen Depo Polyethylene Tank	C96 Pompa C96 Pump	OPR 40-3 Kumanda Opr 40-3 Regulator	Döner Teker Roveller Wheel	Filtre Filter	Krom Fan Chrome Fan
Ürün Kodu Product Code	10200013 (SNPS 600) 10200014 (SNPS 800) 10200015 (SNPS 1000)	10003287 (SNPS 600) 10003289 (SNPS 800) 10003290 (SNPS 1000)	10800006	11000003	10000916	10000355	10000124

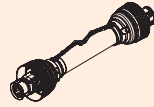
STANDART PARÇALAR
STANDARD PARTS

							
Parça Adı Product Name	Hunili Nozul Funnel Nozzle	Şanzuman Gearbox	Kapak Cover	Elek Sieve	Karıştırıcı Kiti Mixer	Hızlı Doldurucu Hortum Kiti Fast Filling Hose	Şaft Shaft
Ürün Kodu Product Code	10000091	10000281	10000385	10000407	12000017	12000018	10001476

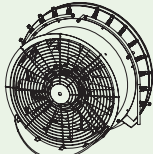
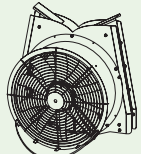
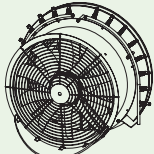
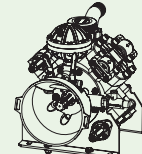
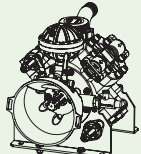
OPSIYONEL PARÇALAR
OPTIONAL PARTS

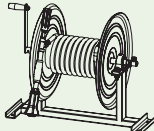
							
Parça Adı Product Name	90'lık Fan 90 Fan	90'lık Kule Fan 90 Tower Fan	90'lık Çift Pervane Fan 90 Double Propeller Fan	C145 Pompa C145 Pump	APS 145 Pompa APS145 Pump	İlaçlama Tabancası Kiti Spray Gun Kit	Hortum Sarma Makara Kiti Hose Reel Kit
Ürün Kodu Product Code	10002094	10000125	10000127	10800004	10000326	10002745	11000174

OPSIYONEL PARÇALAR
OPTIONAL PARTS

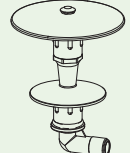
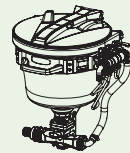
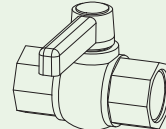
					
Parça Adı Product Name	Toz İlaç Karıştırıcı Powder Chemical Mixer	Mikser Induction Bowl	Menteşeli Kapak Hinged Cover	Boşaltma Vanası Discharge Valve	İthal Nozul Importation Nozzle
Ürün Kodu Product Code	10003326	12000053	10003256	10003835	10000089

RENK SEÇENEKLERİ
COLOR ALTERNATIVES

1	2	3
Şase Chassis	Depo Storage	Şase Chassis
Depo Storage	Şase Chassis	Depo Storage
Yeşil Green	Turuncu Orange	Siyah Black
	Kırmızı Red	Galvaniz Galvanized
		Beyaz White