



# HELIX PS 1000



Kaynak Robot  
Welding Robot



Toz Boya  
Powder Paint



Test Edilmiştir  
Tested



2 Yıl Garanti  
2 Years Warranty

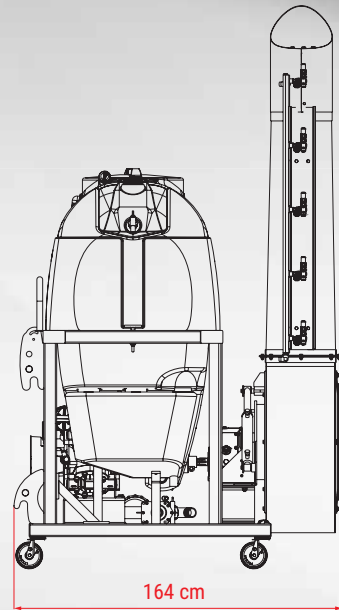
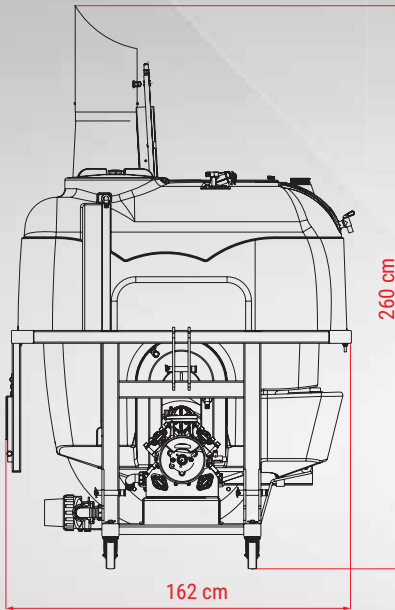

## Yükleme Adetleri / Loading Pcs



5



9



6



12

## Teknik Özellikler / Technical Specifications

Pompa Modeli Pump	Piston membranlı Piston diaphragm	Önallar C145
Pompa Debisi Pump Flowrate	l/dk l/min	145
Pompa Basıncı Pump Pressure	Bar	50
Kontrol Paneli Control Panel		ByMatik
Nozul Tipi Nozzle		Pirinç stoperli atomizör Atomizer brass with stopper
Nozul Sayısı Nr. Of Nozzle		15
Fan Çapı Fan Diameter	cm	84
İş Geniliği Working Width	cm	30 - 35
Gereken Traktör Gücü Required Power	BG HP	70 - 90
Çalışma Devri Speed	dev/dk RPM	540
Hava Debisi Air Flowrate	m <sup>3</sup> /h	66000
Ağırlık Weight	kg	469



Açısı ayarlanabilir atomizör nozulu.  
Angle adjustable atomizer nozzle.



Oluşabilecek kazalara karşı önlem amaçlı fan koruma teli.  
Fan protection string for prevention against accidents.



Kapağa erişimi kolay hale getiren merdiven.  
The stair which provides to access through the cover easier.



Güç kaybını yok eden pompadan fana kademeli olarak aktarımı sağlayan şanzuman ünitesi.  
Gearbox unit which stop the power loss and provides the transfer of power from pump to fan as stepped.



Temizlenebilir filtre ilaçlamanın sağlıklı yapılabilmesini sağlar.  
Cleanable filter enables homogenous spraying.



Dökümünden montajına kadar kendi imalatımız 4 membranlı C145 pompa sınıfında en iyi performansa sahiptir.  
The best quality 4 membrane C145 pump which is manufactured by our factory is the most efficient product of its segment.



Depo Kapağı  
Tank Lid



Hızlı Doldurucu  
Fast Filler



Ana depodan bağımsız el yıkama tankı temiz su ihtiyacını karşılar.  
Hand washing tank apart from main tank supplies clean water.



Homojen ve hassas ilaçlama normu sağlar.  
Homogeneous and Sensitive Disinfection.



Depo yıkama sistemi.  
Tank cleaning system.





# HELIX PS

## C145 Pompa Randıman Değerleri / C145 Pump Productivity Rates

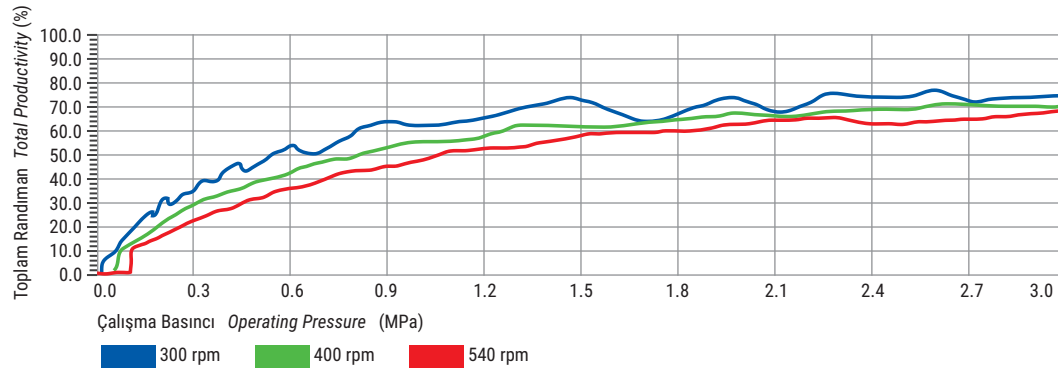

## Depo Doldurucusu Test Sonuçları / Test Results Of Filter

Hidrolik tip venturi depo doldurucusunun;  
Helix PS 600 : 6 dk 18 sn  
Helix PS 800 : 8 dk 24 sn  
Helix PS 1000 : 10 dk 30 sn'de  
3 mpa basınçta 540 devirde doldurduğu tespit edilmiştir.

It is determined that hydraulic type venturi tank filler fills the  
Helix PS 600 : 6 min. 18 sec.  
Helix PS 800 : 8 min. 24 sec.  
Helix PS 1000 : 10 min. 30 sec.  
under operating at 3.0 MPa and 540 rpm cycle.

Bu değerler test ortamında elde edilmiş olup,  
şartlara bağlı olarak değişkenlik gösterebilir.

These values are obtained in the test environment  
and may vary depending on the conditions.

## Hortum Test Sonuçları / Test Results Of Hose

Makinada bulunan hortumların, hortum deney standında çalışma basıncının 3 katı statik basınç altında (9.0 MPa) deforme olmadığı, çap ve form değişikliğine uğramadığı tespit edilmiştir.

Any deformation is not detected on the hoses which are used on the machine, in spite of practicing pressure over three times (9.0 MPa) than operating pressure.

## C145 Pompa Verdi Değerleri / C145 Pump Flowrate Rates

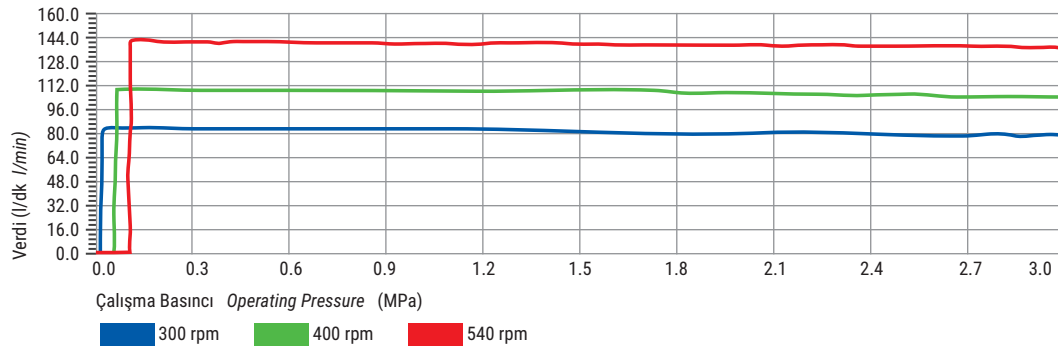

## Süzgeçler / Sieves

Kullanım Yeri Place Of Use	Tipi Type	Malzeme Material Type	Delik Sayısı adet/cm <sup>2</sup> Hole Quantity pcs/cm <sup>2</sup>	Süzme Oranı % Sieving Rate
Depo Doldurma Ağız Süzgeci Tank Filler Opening Sieve	Dikdörtgen delikli Rectangular Perforated	Plastik Örgü Plastic Mesh	180	40
Depo Doldurucu Süzgeci Tank Filler Sieve	Kare delikli Square Perforated	Cr+Ni Tel örgü Cr+Ni Wire Mesh	256	33
Depo Çıkış Süzgeci Tank Output Sieve	Kare delikli Square Perforated	Cr+Ni Tel örgü Cr+Ni Wire Mesh	144	30
Malzeme Süzgeci Material Sieve	Kare delikli Square Perforated	Cr+Ni Tel örgü Cr+Ni Wire Mesh	576	56

## Makine Çalışma Sistemi / Machine Working Principle

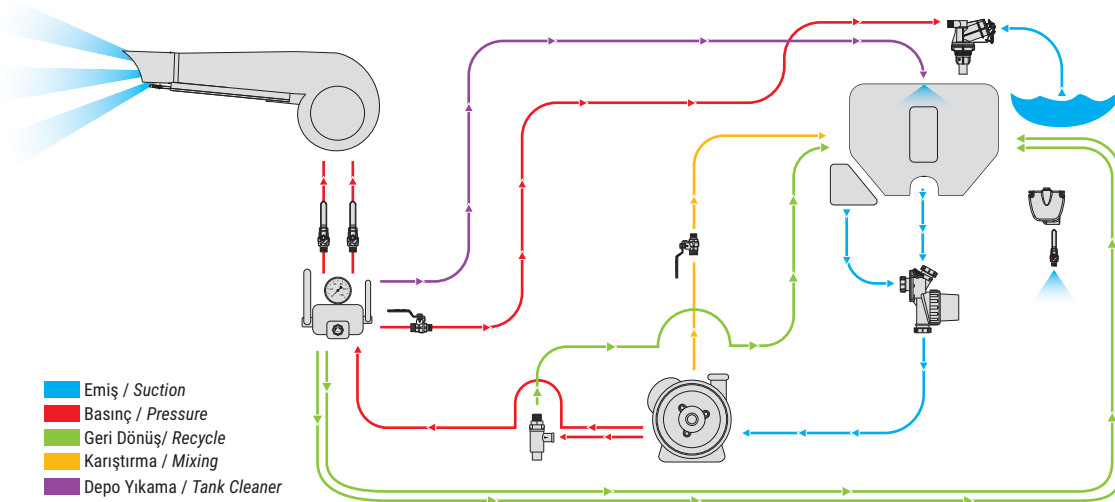

## Nozul İlaçlama Şekilleri / Nozzle Spraying Types

Atomizör Nozul  
Atomizer Nozzle

Plaket delik çapları  
Plate hole diameter

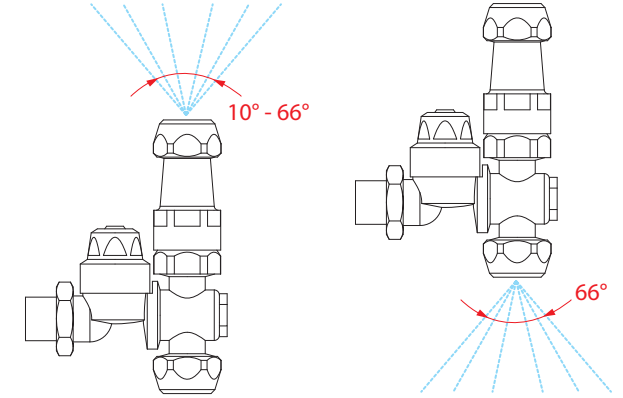

0.8 mm  
1.0 mm  
1.2 mm  
1.5 mm  
1.8 mm



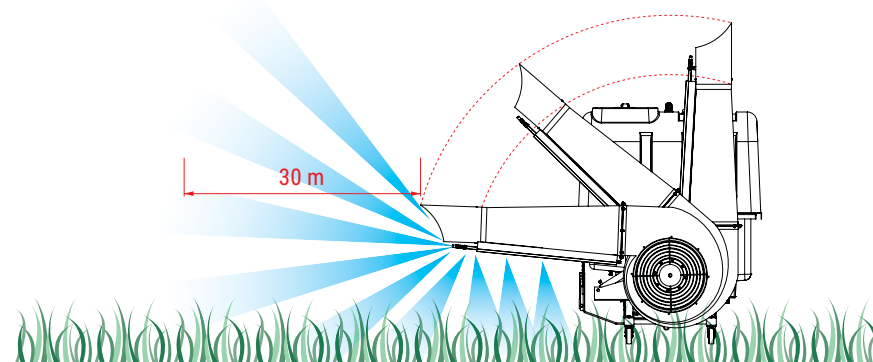

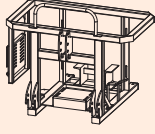
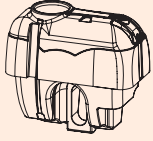
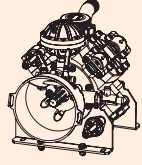
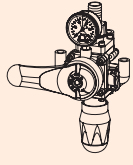
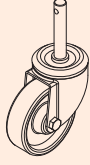
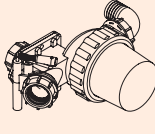

## Makine İlaçlama Şekilleri / Machine Spraying Types



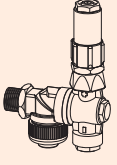

STANDART PARÇALAR  
STANDARD PARTS

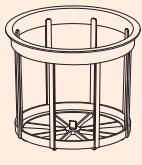
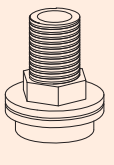
							
Parça Adı Product Name	Şase Chassis	Polietilen Depo Polyethylene Tank	C145 Pompa C145 Pump	ByMatik Kumanda ByMatik Regulator	Döner Teker Roveller Wheel	Filtre Filter	Helix Fan Helix Fan
Ürün Kodu Product Code	10200020 (PS 600) 10200021 (PS 800) 10200022 (PS 1000)	10003287 (PS 600) 10003289 (PS 800) 10003290 (PS 1000)	10800004	10000333	10000916	10000355	10000128

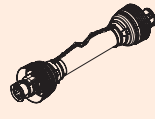
STANDART PARÇALAR  
STANDARD PARTS

						
Parça Adı Product Name	Atomizör Nozul Atomizer Nozzle	Kapak Cover	Elek Sieve	Karıştırıcı Kiti Mixer	Hızlı Doldurucu Hortum Kiti Fast Filling Hose	Şaft Shaft
Ürün Kodu Product Code	10000090	10000385	10000407	12000017	12000018	10001476

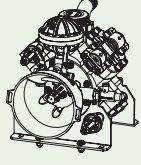
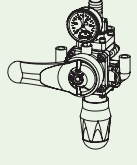

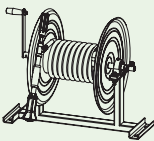

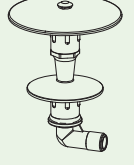
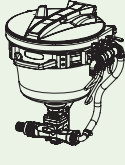
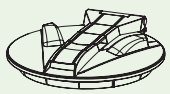
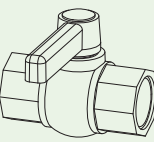

OPSİYONEL PARÇALAR  
OPTIONAL PARTS

				
Parça Adı Product Name	APS145 Pompa APS145 Pump	Braglia Kumanda Braglia Regulator	İlaçlama Tabancası Kiti Spray Gun Kit	Hortum Sarma Makara Kiti Hose Reel Kit
Ürün Kodu Product Code	10000326	10002690	10002745	11000174

OPSİYONEL PARÇALAR  
OPTIONAL PARTS

				
Parça Adı Product Name	Toz İlaç Karıştırıcı Powder Chemical Mixer	Mikser Induction Bowl	Menteşeli Kapak Hinged Cover	Boşaltma Vanası Discharge Valve
Ürün Kodu Product Code	10003326	12000053	10003257	10003835

RENK SEÇENEKLERİ  
COLOR ALTERNATIVES

1	2	3			
Şase Chasis	Depo Storage	Şase Chasis	Depo Storage	Şase Chasis	Depo Storage
					
Yeşil Green	Turuncu Orange	Siyah Black	Kırmızı Red	Galvaniz Galvanized	Beyaz White