



HELIX YPS 360 1000



Kaynak Robot
Welding Robot



Toz Boya
Powder Paint



Test Edilmiştir
Tested



2 Yıl Garanti
2 Years Warranty

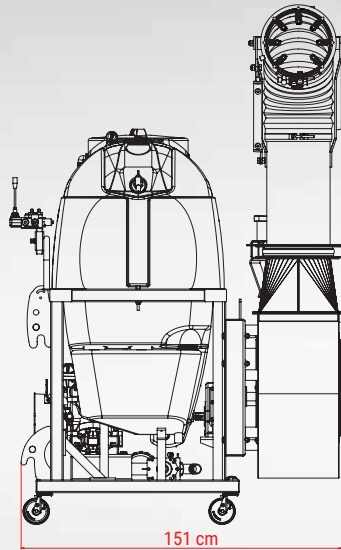
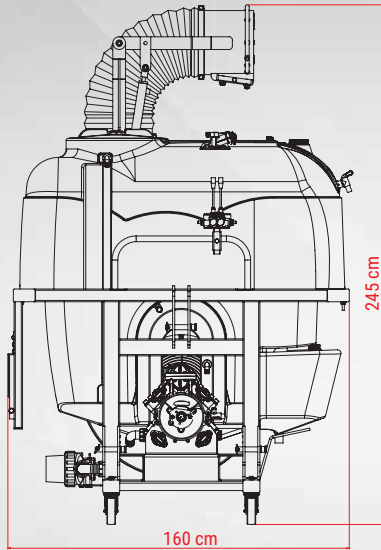

Yükleme Adetleri / Loading Pcs



6



10



5



12

Teknik Özellikler / Technical Specifications

Pompa Modeli Pump	Piston membranlı Piston diaphragm	Önallar C145
Pompa Debisi Pump Flowrate	l/dk l/min	145
Pompa Basıncı Pump Pressure	Bar	50
Kontrol Paneli Control Panel		ByMatik
Nozul Tipi Nozzle		Pirinç stoperli atomizör Atomizer brass with stopper
Nozul Sayısı Nr. Of Nozzle		9
İş Genişliği Working Width	cm	40 - 45
Gereken Traktör Gücü Required Power	BG HP	80 - 90
Çalışma Devri Speed	dev/dk RPM	540
Hava Debisi Air Flowrate	m ³ /h	66000
Yatay Dönüş Horizontal Rotation	°	270
Dikey Dönüş Vertical Rotation	°	210
Ağırlık Weight	kg	643



270° açı ile ilaçlama
imkanı sağlar.
Enables spraying to
270° angle.



Depo Kapağı
Tank Lid



Hız ayarlı şanzuman ünitesi.
Speed adjustable gearbox unit.



Hızlı Doldurucu
Fast Filler



Açısı ayarlanabilir atomizör
memesi.
Angle adjustable atomizer
nozzle.



Ana depodan bağımsız el yıkama
tankı temiz su ihtiyacını karşılar.
Hand washing tank apart from main
tank supplies clean water.



Oluşabilecek kazalara karşı
önlem amaçlı fan koruma teli.
Fan protection string for
prevention against accidents.

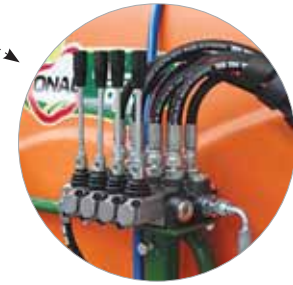

Hidrolik liflerin uzaktan
kontrolünü sağlar.
Provides the distant control of
hydraulic lifts



Kapağa erişimi
kolay hale getiren
merdiven.
The Stair which provides
to access through the
cover easier.



Homojen ve hassas
ilaçlama normu sağlar.
Homogeneous and
Sensitive Disinfection.



Temizlenebilir filtre ilaçlamanın
sağlıklı yapılabilmesini sağlar.
Cleanable filter enables
homogenous spraying.



Dökümünden montajına kadar kendi
imalatımız 4 membranlı C145 pompa
sınıfında en iyi performansa sahiptir.
The best quality 4 membrane C145 pump
which is manufactured by our factory is
the most efficient product of its segment.



Depo yıkama sistemi.
Tank cleaning system.



HELIX YPS 360

C145 Pompa Randıman Değerleri / C145 Pump Productivity Rates

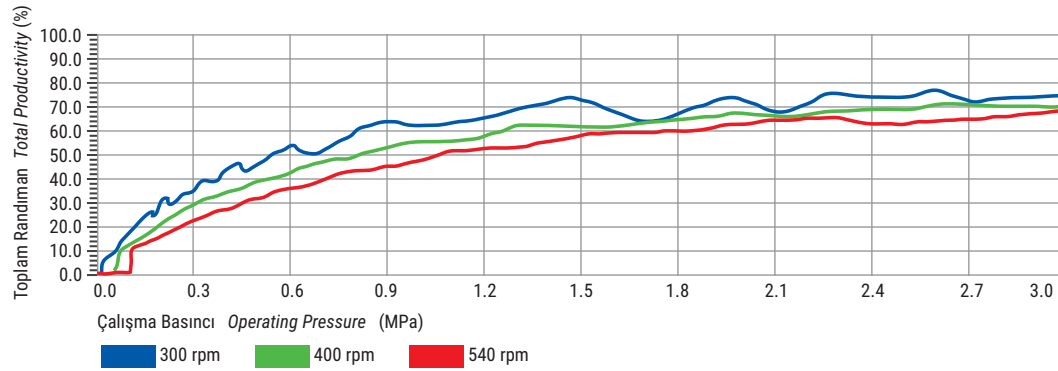

Depo Doldurucusu Test Sonuçları / Test Results Of Filter

Hidrolik tip venturi depo doldurucusunun; Helix YPS 360 1000 : 8 dk 1 sn 3 mpa basınçta 540 devirde doldurduğu tespit edilmiştir.

It is determined that hydraulic type venturi tank filler fills the Helix YPS 360 1000 : 8 min. 1 sec. under operating at 3.0 MPa and 540 rpm cycle.

Bu değerler test ortamında elde edilmiş olup, şartlara bağlı olarak değişkenlik gösterebilir.

These values are obtained in the test environment and may vary depending on the conditions.

Hortum Test Sonuçları / Test Results Of Hose

Makinada bulunan hortumların, hortum deney standında çalışma basıncının 3 katı statik basınç altında (9.0 MPa) deforme olmadığı, çap ve form değişikliğine uğramadığı tespit edilmiştir.

Any deformation is not detected on the hoses which are used on the machine, in spite of practicing pressure over three times (9.0 MPa) than operating pressure.

C145 Pompa Verdi Değerleri / C145 Pump Flowrate Rates

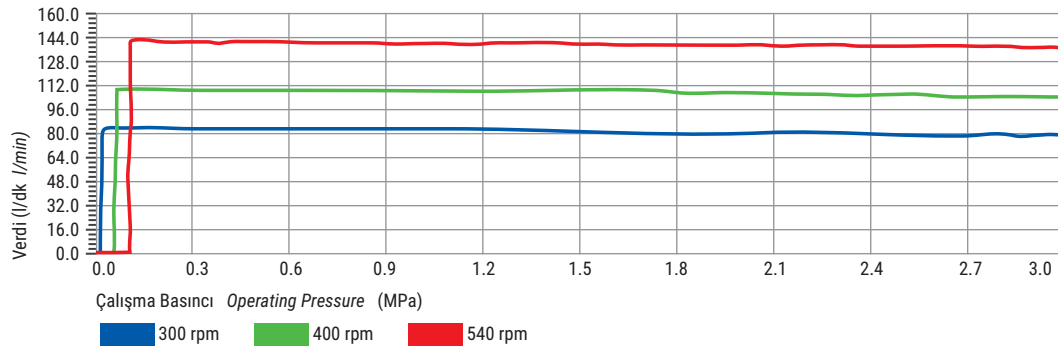

Süzgeçler / Sieves

Kullanım Yeri / Place Of Use	Tipi / Type	Malzeme / Material Type	Delik Sayısı adet/cm ² / Hole Quantity pcs/cm ²	Süzme Oranı % / Sieving Rate
Depo Doldurma Ağız Süzgeci / Tank Filler Opening Sieve	Dikdörtgen delikli / Rectangular Perforated	Plastik Örgü / Plastic Mesh	180	40
Depo Doldurucu Süzgeci / Tank Filler Sieve	Kare delikli / Square Perforated	Cr+Ni Tel örgü / Cr+Ni Wire Mesh	256	33
Depo Çıkış Süzgeci / Tank Output Sieve	Kare delikli / Square Perforated	Cr+Ni Tel örgü / Cr+Ni Wire Mesh	144	30
Malzeme Süzgeci / Material Sieve	Kare delikli / Square Perforated	Cr+Ni Tel örgü / Cr+Ni Wire Mesh	576	56

Makine Çalışma Sistemi / Machine Working Principle

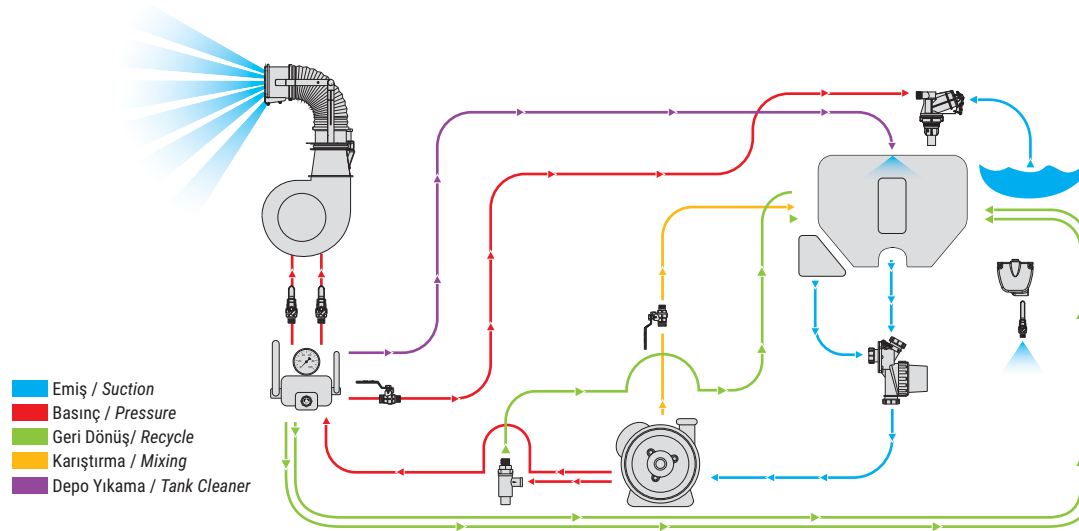

Nozul İlaçlama Şekilleri / Nozzle Spraying Types

Atomizör Nozul / Atomizer Nozzle

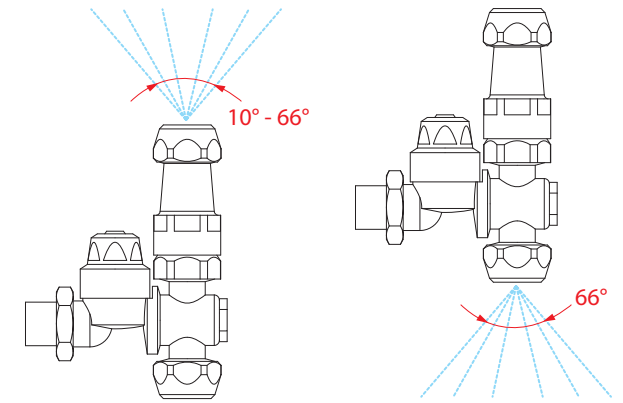

Plaket delik çapları / Plate hole diameter
0.8 mm
1.0 mm
1.2 mm
1.5 mm
1.8 mm



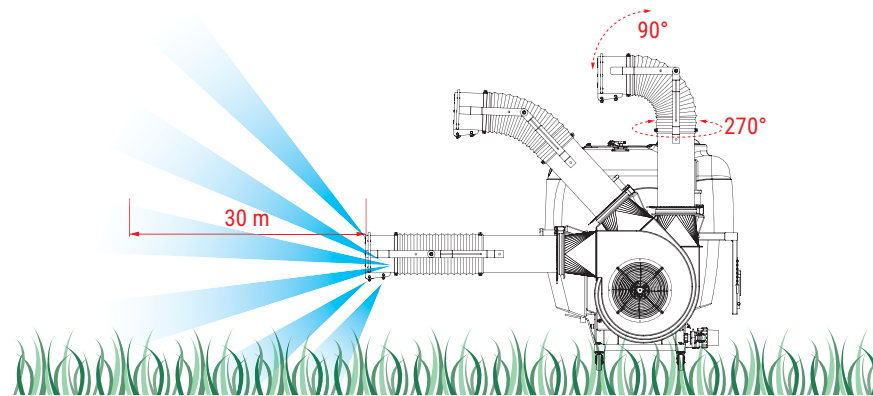

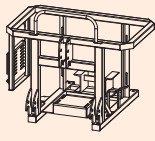
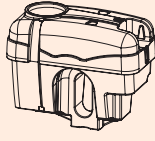
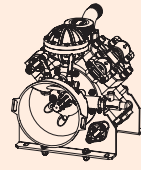
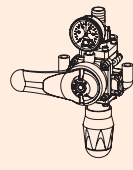
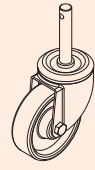
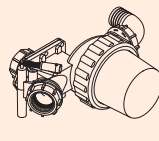
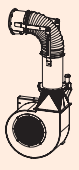
Makine İlaçlama Şekilleri / Machine Spraying Types

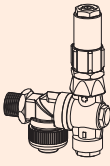
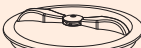
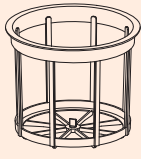
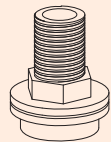



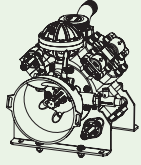
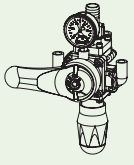

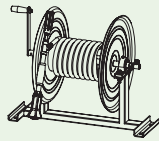

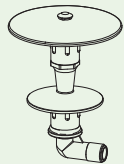
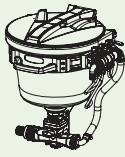
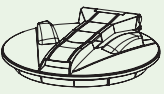
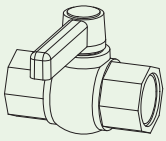
STANDART PARÇALAR STANDARD PARTS							
	Şase Product Name Chassis	Polietilen Depo Polyethylene Tank	C145 Pompa C145 Pump	ByMatik Kumanda ByMatik Regulator	Döner Teker Roveler Wheel	Filtre Filter	270° Fan 270° Fan
	Ürün Kodu Product Code	10200028	10003290	10800004	10000333	10000916	10000355

STANDART PARÇALAR STANDARD PARTS						
	Atomizör Nozul Atomizer Nozzle	Kapak Cover	Elek Sieve	Karıştırıcı Kiti Mixer	Hızlı Doldurucu Hortum Kiti Fast Filling Hose	Şaft Shaft
	Ürün Kodu Product Code	10000090	10000385	10000407	12000017	12000018

OPSİYONEL PARÇALAR OPTIONAL PARTS				
	APS145 Pompa APS145 Pump	Braglia Kumanda Braglia Regulator	İlaçlama Tabancası Kiti Spray Gun Kit	Hortum Sarma Makara Kiti Hose Reel Kit
	Ürün Kodu Product Code	10000326	10002690	10002745

OPSİYONEL PARÇALAR OPTIONAL PARTS				
	Toz İlaç Karıştırıcı Powder Chemical Mixer	Mikser Induction Bowl	Menteşeli Kapak Hinged Cover	Boşaltma Vanası Discharge Valve
	Ürün Kodu Product Code	10003326	12000053	10003257

RENK SEÇENEKLERİ COLOR ALTERNATIVES	1		2		3	
	Şase Chasis	Depo Storage	Şase Chasis	Depo Storage	Şase Chasis	Depo Storage
						
Yeşil Green	Turuncu Orange	Siyah Black	Kırmızı Red	Galvaniz Galvanized	Beyaz White	