

# LEPUS SF 1000



Kaynak Robot  
Welding Robot



Toz Boya  
Powder Paint



Test Edilmiştir  
Tested



2 Yıl Garanti  
2 Years Warranty

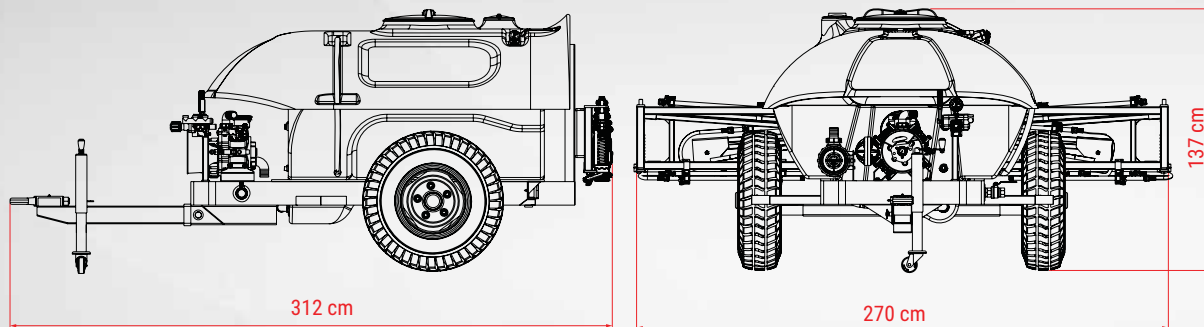

## Yükleme Adetleri / Loading Pcs



4



14



0



10

## Teknik Özellikler / Technical Specifications

Pompa Modeli Pump	Piston membranlı Piston diaphragm	Önallar C96
Pompa Debisi Pump Flowrate	l/dk l/min	96
Pompa Basıncı Pump Pressure	Bar	50
Kontrol Paneli Control Panel		OPR 40-3
İş Genişliği Working Width	m	12
Nozul Tipi Nozzle		Konik hüzmeli piriç Conic beamed and clamped
Nozul Sayısı Nr. Of Nozzle		25
Nozullar Arası Mesafe The Distance Between Nozzle	cm	50
İlaçlama Kolu Yüksekliği Ayarı Boom Height Adjustment		Manuel Manual
İlaçlama Kolu Katlanması Boom Opening Adjustment		Manuel Manual
Gereken Traktör Gücü Required Power	BG HP	50
Çalışma Devri Speed	dev/dk RPM	540
Ağırlık Weight	kg	410



Ana depodan bağımsız el yıkama tankı temiz su ihtiyacını karşılar.  
*Hand washing tank apart from main tank supplies clean water.*

Hızlı Doldurucu  
*Fast filler*

Depo kapağı  
*Tank lid*

Homojen ve hassas ilaçlama normu sağlar  
*Homogeneous and sensitive disinfection.*

Baskı yayına sahip kilit sistemi kolun stabil olarak açılıp kapanmasını sağlar.  
*Lock system with tension spring provides proper opening and closing of booms.*

İlaçlama bitiminde depoda kalan suyun tahliyesini sağlar.  
*Provides the ejection of residual water in the tank.*

Uzun ömürlü ve temizlenebilir meme homojen ilaçlama yapar.  
*Long-lasting and cleanable nozzle provides homogeneous disinfection.*

Trafikte güvenliği sağlayan stop lambaları.  
*Stop lights which provide to safety on traffic.*

Her türlü arazi koşuluna dayanıklı tekerler.  
*Durable wheels to all of terrain conditions.*

Temizlenebilir filtre ilaçlamanın sağlıklı yapılabilmesini sağlar.  
*Cleanable filter enables homogenous spraying.*

Dökümünden montajına kadar kendi imalatımız 4 membranlı C96 pompa sınıfında en iyi performansa sahiptir.  
*The best quality 4 membrane C96 pump which is manufactured by our factory is the most efficient product of its segment.*

Yükseklik ayarına sahip, traktöre kolay bağlanabilen çeki oku.  
*Easy mountable drawbar with height control.*





# LEPUS SF

## C96 Pompa Randıman Değerleri / C96 Pump Productivity Rates

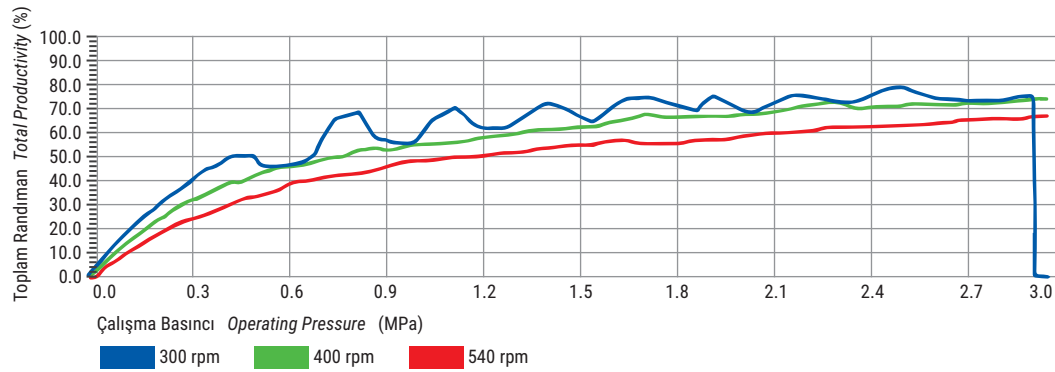

## C96 Pompa Verdi Değerleri / C96 Pump Flowrate Rates

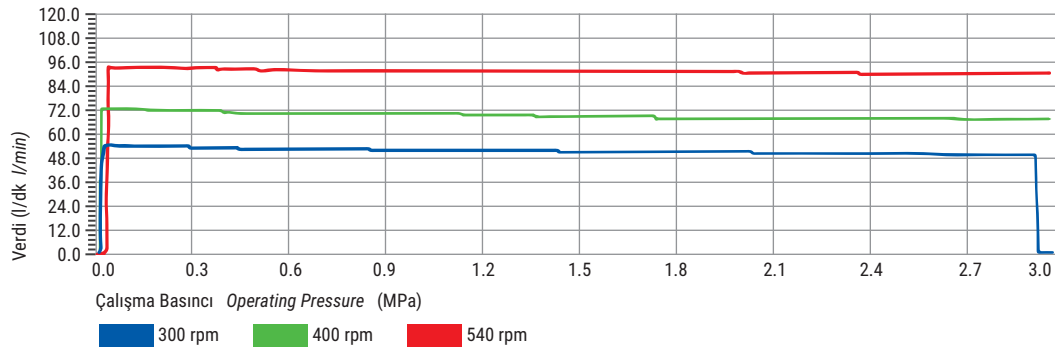

## Makine Çalışma Sistemi / Machine Working Principle

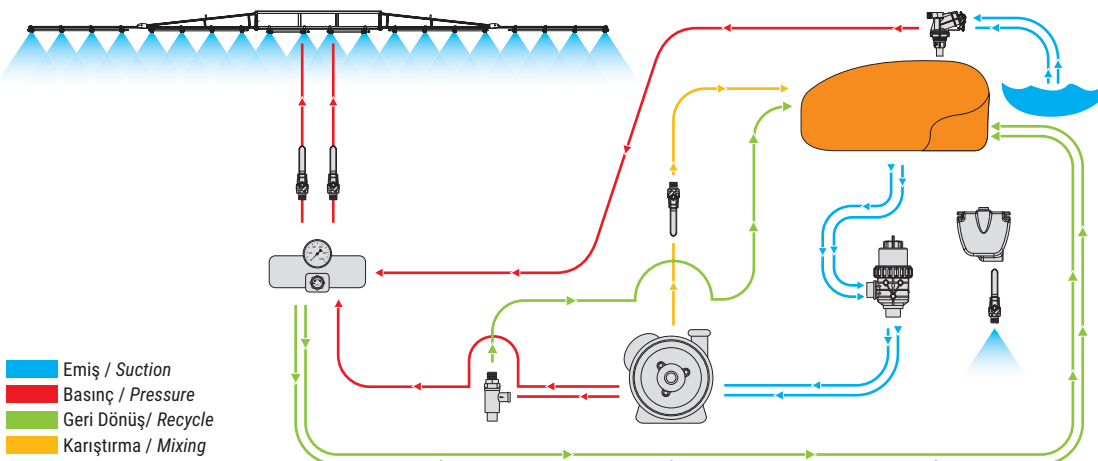

Ayarlanabilir Yükseklik  
Adjustable Height

88 cm  
min 50 cm

8 Metre Kol 8 m Boom / 35 kg / Nozul Dağılımı Nozzle Distribution : 2 4 4 4 2

88 cm  
min 50 cm

10 Metre Kol 10 m Boom / 41 kg / Nozul Dağılımı Nozzle Distribution : 4 4 4 4 4

88 cm  
min 50 cm

12 Metre Kol 12 m Boom / 63 kg / Nozul Dağılımı Nozzle Distribution : 5 5 5 5 5

## Depo Doldurucusu Test Sonuçları / Test Results Of Filter

Hidrolik tip venturi depo doldurucusunun;

Lepus SF 1000 : 7 dk 30 sn

Lepus SF 1600 : 10 dk 5 sn

Lepus SF 2000 : 12 dk 40 sn'de

3 mpa basınçta 540 devirde doldurduğu tespit edilmiştir.

It is determined that hydraulic type venturi tank filler fills the

Lepus SF 1000 : 7 min. 30 sec.

Lepus SF 1600 : 10 min. 5 sec.

Lepus SF 2000 : 12 min. 40 sec.

under operating at 3.0 MPa and 540 rpm cycle.

Bu değerler test ortamında elde edilmiş olup, şartlara bağlı olarak değişkenlik gösterebilir.

These values are obtained in the test environment and may vary depending on the conditions.

## Hortum Test Sonuçları / Test Results Of Hose

Makinada bulunan hortumların, hortum deney standında çalışma basıncının 3 katı statik basınç altında (9.0 MPa) deforme olmadığı, çap ve form değişikliğine uğramadığı tespit edilmiştir.

Any deformation is not detected on the hoses which are used on the machine, in spite of practicing pressure over three times (9.0 MPa) than operating pressure.

## Süzgeçler / Sieves

Kullanım Yeri Place Of Use	Tipi Type	Malzeme Material Type	Delik Sayısı adet/cm <sup>2</sup> Hole Quantity pcs/cm <sup>2</sup>	Süzme Oranı % Sieving Rate
Depo Doldurma Ağız Süzgeci Tank Filler Opening Sieve	Dikdörtgen delikli Rectangular Perforated	Plastik Örgü Plastic Mesh	180	40
Depo Doldurucu Süzgeci Tank Filler Sieve	Kare delikli Square Perforated	Cr+Ni Tel örgü Cr+Ni Wire Mesh	256	33
Depo Çıkış Süzgeci Tank Output Sieve	Kare delikli Square Perforated	Cr+Ni Tel örgü Cr+Ni Wire Mesh	144	30
Malzeme Süzgeci Material Sieve	Kare delikli Square Perforated	Cr+Ni Tel örgü Cr+Ni Wire Mesh	576	56

## Nozullar Arası Mesafe / Distance Between Nozzles

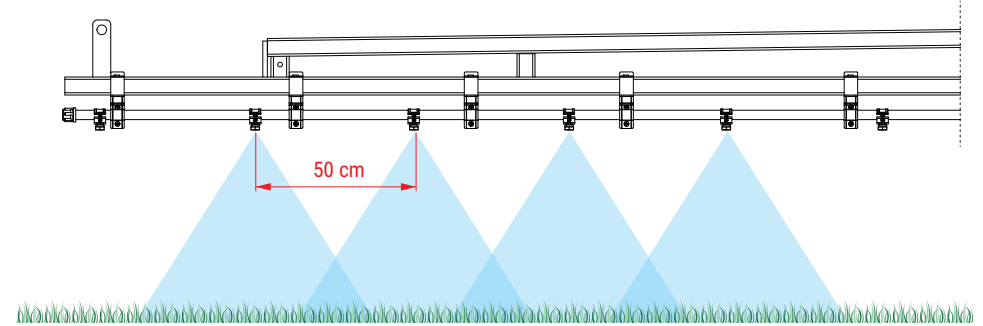

## Nozul İlaçlama Şekilleri / Nozzle Spraying Types

Konik Hüzmeli Nozul  
Chonic Brass Nozzle

Plaket delik çapları  
Plate hole diameter  
0.8 mm  
1.0 mm  
1.2 mm  
1.5 mm  
2.0 mm

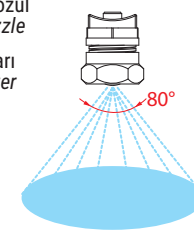



Yelpaze Hüzmeli Nozul  
Curtain Spray Nozzle

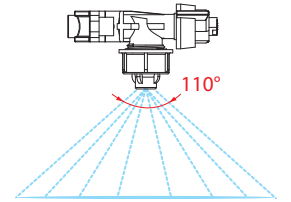

Plaket delik çapları  
Plate hole diameter  
110-01 110-04  
110-015 110-05  
110-02 110-06  
110-025 110-08  
110-03

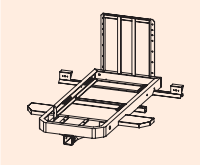
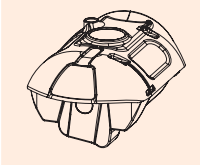
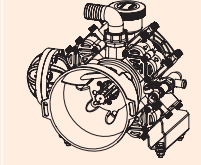
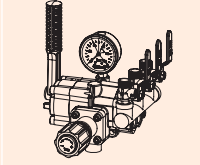

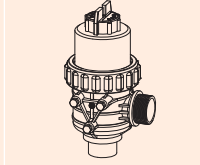
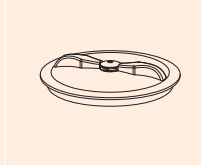
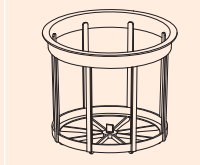

STANDART PARÇALAR  
STANDARD PARTS

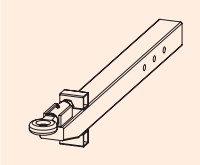
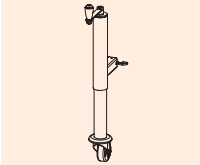
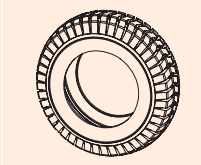
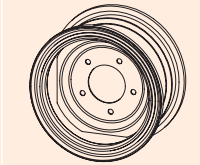
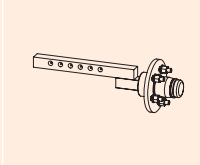
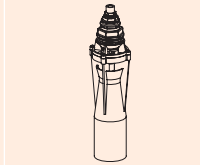
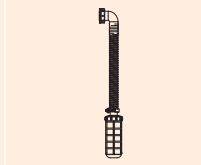
								
Parça Adı Product Name	Şase Chassis	Polyester Depo Polyester Tank	C96 Pompa C96 Pump	OPR 40-3 Kumanda Opr 40-3 Regulator	12 m Kol 12 m Boom	Filtre Filter	Kapak Cover	Elek Sieve
Ürün Kodu Product Code	10400001 (SF 1000) 10400002 (SF 1600) 10400003 (SF 2000)	10003280 (SF 1000) 10003281 (SF 1600) 10003282 (SF 2000)	10800003	11000003	10600005	10000356	10000385	10000407

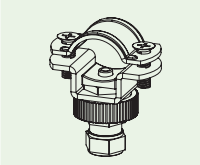
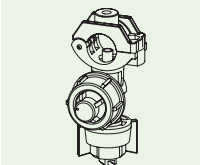
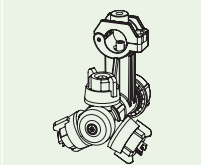
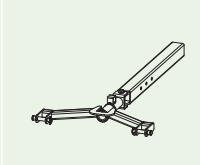
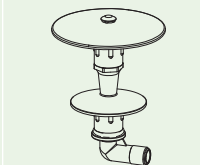

STANDART PARÇALAR  
STANDARD PARTS

								
Parça Adı Product Name	Çeki Oku Drawbar	Kriko Lever Jack	Lastik Tire	Jant Wheel Rim	Porya Hub	Karıştırıcı Mixer	Hızlı Doldurucu Hortum Kiti Fast Filling Hose	Şaft Shaft
Ürün Kodu Product Code	10400046	10400047	10000875 (SF 1000) 10000884 (SF 1600) 10000884 (SF 2000)	10000861 (SF 1000) 10000885 (SF 1600) 10000885 (SF 2000)	10000268	10000408	12000058	10001220

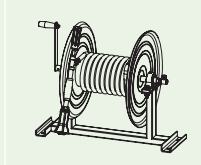



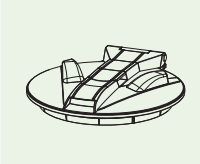
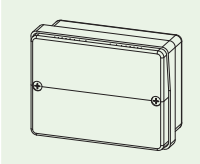
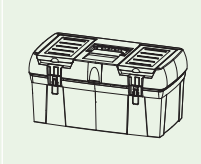

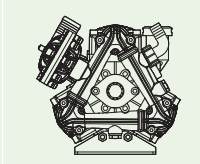
OPSİYONEL PARÇALAR  
OPTIONAL PARTS

							
Parça Adı Product Name	Tombul Nozul Conic Brass Nozzle	Yelpaze Hüzmeleli Nozul Single Curtain Spray Nozzle	Üçlü Yelpaze Hüzmeleli Nozul Triple Curtain Spray Nozzle	Döner Kafalı Çeki Oku Revolver Head Drawbar	Toz İlaç Karıştırıcı Powder Chemical Mixer	İlaçlama Tabancası Kiti Spray Gun Kit	Hortum Sarma Makara Kiti Hose Reel Kit
Ürün Kodu Product Code	10000177	10000405	10000406	10400050	10003326	10002745	11000174

OPSİYONEL PARÇALAR  
OPTIONAL PARTS

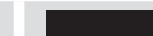
					
Parça Adı Product Name	Menteşeli Kapak Hinged Cover	Stop Lambası Stop Light	Takım Çantası Tool Box	Krom İlaçlama Borusu Chrome Pipe	Düşük Basıncılı Pompa Low Pressure Pump
Ürün Kodu Product Code	10003256	10000276	10001177	12000057	10800007

RENK  
SEÇENEKLERİ  
COLOR  
ALTERNATIVES

	1		2		3	
	Şase Chasis	Depo Storage	Şase Chasis	Depo Storage	Şase Chasis	Depo Storage
						
	Yeşil Green	Turuncu Orange	Siyah Black	Kırmızı Red	Galvaniz Galvanized	Beyaz White