

LEPUS SF 2000



Kaynak Robot
Welding Robot



Toz Boya
Powder Paint



Test Edilmiştir
Tested



2 Yıl Garanti
2 Years Warranty

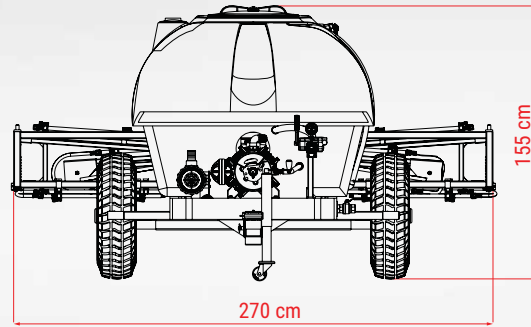
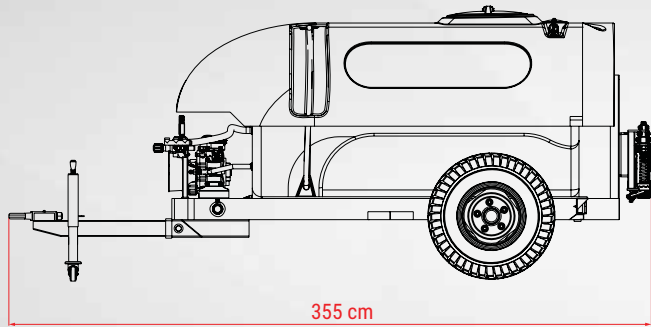

Yükleme Adetleri / Loading Pcs



4

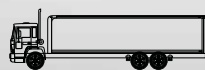

14



0



10

Teknik Özellikler / Technical Specifications

| | | |
|--|--------------------------------------|--|
| Pompa Modeli Pump | Piston membranlı Piston diaphragm | Önallar C96 |
| Pompa Debisi Pump Flowrate | l/dk l/min | 96 |
| Pompa Basıncı Pump Pressure | Bar | 50 |
| Kontrol Paneli Control Panel | | OPR 40-3 |
| İş Genişliği Working Width | m | 12 |
| Nozul Tipi Nozzle | | Konik hüzmeli pirinç Conic beamed and clamped |
| Nozul Sayısı Nr. Of Nozzle | | 25 |
| Nozullar Arası Mesafe The Distance Between Nozzle | cm | 50 |
| İlaçlama Kolu Yüksekliği Ayarı Boom Height Adjustment | | Manuel Manual |
| İlaçlama Kolu Katlanması Boom Opening Adjustment | | Manuel Manual |
| Gerekten Traktör Gücü Required Power | BG HP | 50 |
| Çalışma Devri Speed | dev/dk RPM | 540 |
| Ağırlık Weight | kg | 478 |



Ana depodan bağımsız el yıkama tankı temiz su ihtiyacını karşılar.
Hand washing tank apart from main tank supplies clean water.

Hızlı Doldurucu
Fast filler

Depo kapağı
Tank lid

Kolay okunabilir kadranlı seviye göstergesi.
Easy readable dial level indicator.

Homojen ve hassas ilaçlama normu sağlar.
Homogeneous and sensitive disinfection.

Baskı yayına sahip kilit sistemi kolun stabil olarak açılıp kapanmasını sağlar.
Lock system with tension spring provides proper opening and closing of booms.

İlaçlama bitiminde depoda kalan suyun tahliyesini sağlar.
Provides the ejection of residual water in the tank.

Uzun ömürlü ve temizlenebilir meme homojen ilaçlama yapar.
Long-lasting and cleanable nozzle provides homogeneous disinfection.

Trafikte güvenliği sağlayan stop lambaları.
Stop lights which provide to safety on traffic.

Her türlü arazi koşuluna dayanıklı tekerler.
Durable wheels to all of terrain conditions.

Temizlenebilir filtre ilaçlamanın sağlıklı yapılabilmesini sağlar.
Cleanable filter enables homogenous spraying.

Dökümünden montajına kadar kendi imalatımız 4 membranlı C96 pompa sınıfında en iyi performansa sahiptir.
The best quality 4 membrane C96 pump which is manufactured by our factory is the most efficient product of its segment.

Yükseklik ayarına sahip, traktöre kolay bağlanabilen çeki oku.
Easy mountable drawbar with height control.



LEPUS SF

C96 Pompa Randıman Değerleri / C96 Pump Productivity Rates

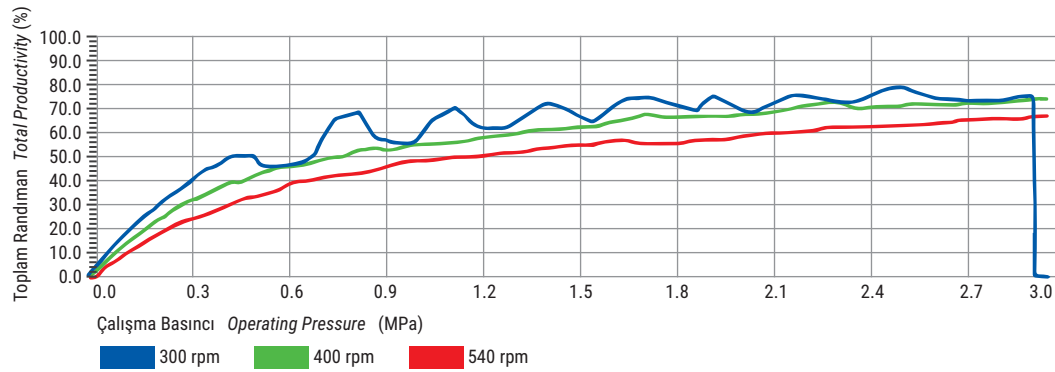

C96 Pompa Verdi Değerleri / C96 Pump Flowrate Rates

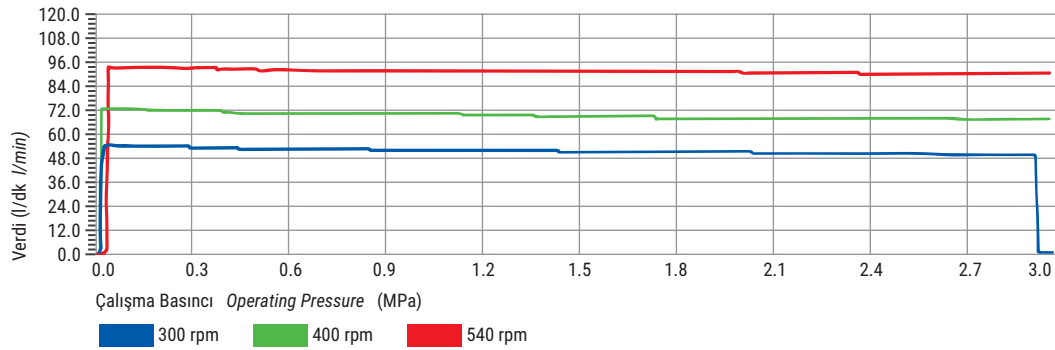

Makine Çalışma Sistemi / Machine Working Principle

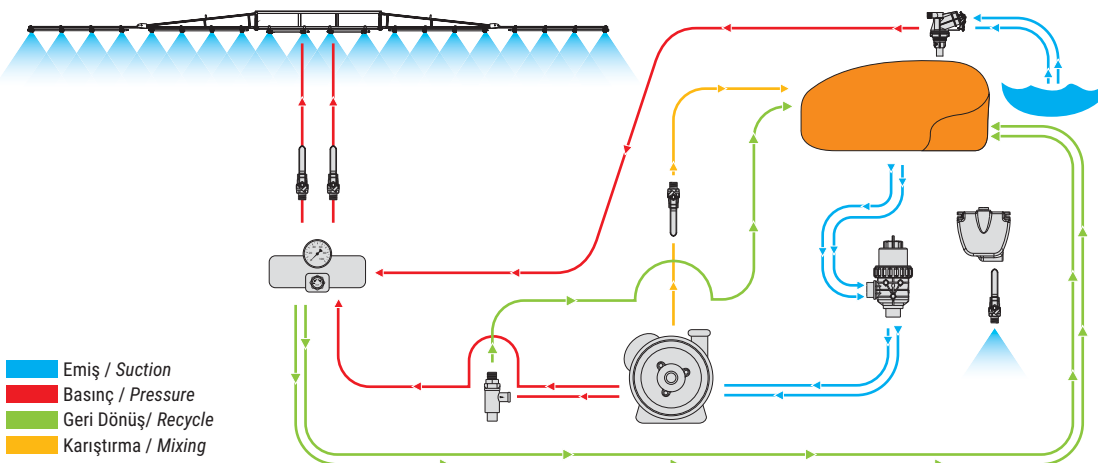

Ayarlanabilir Yükseklik
Adjustable Height

88 cm
min 50 cm

8 Metre Kol 8 m Boom / 35 kg / Nozul Dağılımı Nozzle Distribution : 2 4 4 4 2

88 cm
min 50 cm

10 Metre Kol 10 m Boom / 41 kg / Nozul Dağılımı Nozzle Distribution : 4 4 4 4 4

88 cm
min 50 cm

12 Metre Kol 12 m Boom / 63 kg / Nozul Dağılımı Nozzle Distribution : 5 5 5 5 5

Depo Doldurucusu Test Sonuçları / Test Results Of Filter

Hidrolik tip venturi depo doldurucusunun;

Lepus SF 1000 : 7 dk 30 sn

Lepus SF 1600 : 10 dk 5 sn

Lepus SF 2000 : 12 dk 40 sn'de

3 mpa basınçta 540 devirde doldurduğu tespit edilmiştir.

It is determined that hydraulic type venturi tank filler fills the

Lepus SF 1000 : 7 min. 30 sec.

Lepus SF 1600 : 10 min. 5 sec.

Lepus SF 2000 : 12 min. 40 sec.

under operating at 3.0 MPa and 540 rpm cycle.

Bu değerler test ortamında elde edilmiş olup, şartlara bağlı olarak değişiklik gösterebilir.

These values are obtained in the test environment and may vary depending on the conditions.

Hortum Test Sonuçları / Test Results Of Hose

Makinada bulunan hortumların, hortum deney standında çalışma basıncının 3 katı statik basınç altında (9.0 MPa) deforme olmadığı, çap ve form değişikliğine uğramadığı tespit edilmiştir.

Any deformation is not detected on the hoses which are used on the machine, in spite of practicing pressure over three times (9.0 MPa) than operating pressure.

Süzgeçler / Sieves

| Kullanım Yeri Place Of Use | Tipi Type | Malzeme Material Type | Delik Sayısı adet/cm ² Hole Quantity pcs/cm ² | Süzme Oranı % Sieving Rate |
|--|--|-----------------------------------|--|-------------------------------|
| Depo Doldurma Ağız Süzgeci Tank Filler Opening Sieve | Dikdörtgen delikli Rectangular Perforated | Plastik Örgü Plastic Mesh | 180 | 40 |
| Depo Doldurucu Süzgeci Tank Filler Sieve | Kare delikli Square Perforated | Cr+Ni Tel örgü Cr+Ni Wire Mesh | 256 | 33 |
| Depo Çıkış Süzgeci Tank Output Sieve | Kare delikli Square Perforated | Cr+Ni Tel örgü Cr+Ni Wire Mesh | 144 | 30 |
| Malzeme Süzgeci Material Sieve | Kare delikli Square Perforated | Cr+Ni Tel örgü Cr+Ni Wire Mesh | 576 | 56 |

Nozullar Arası Mesafe / Distance Between Nozzles

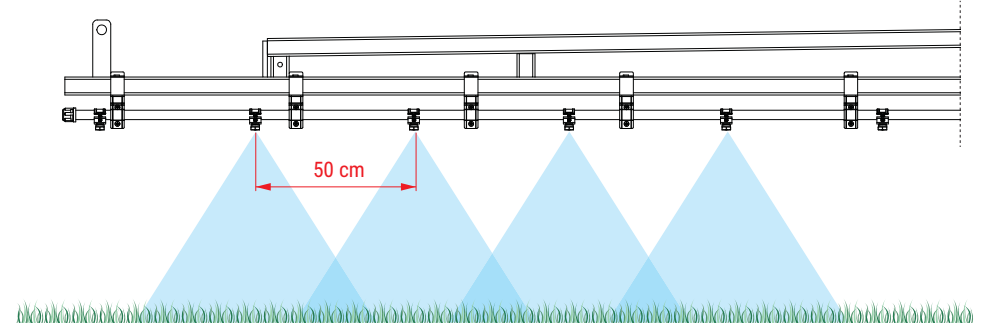

Nozul İlaçlama Şekilleri / Nozzle Spraying Types

Konik Hüzmeli Nozul
Chonic Brass Nozzle

Plaket delik çapları
Plate hole diameter
0.8 mm
1.0 mm
1.2 mm
1.5 mm
2.0 mm

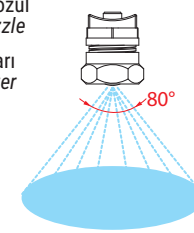

Yelpaze Hüzmeli Nozul
Curtain Spray Nozzle

Plaket delik çapları
Plate hole diameter
110-01 110-04
110-015 110-05
110-02 110-06
110-025 110-08
110-03

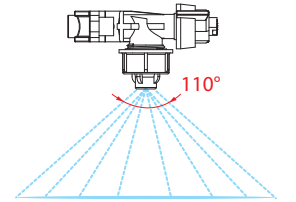

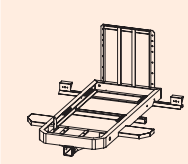
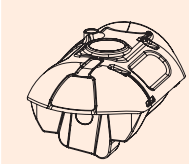
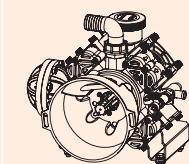
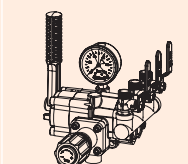
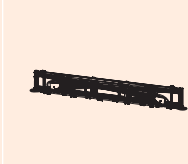
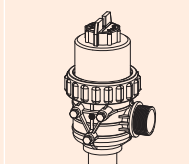
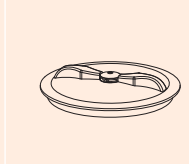
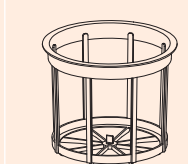

STANDART PARÇALAR
STANDARD PARTS

| | | | | | | | | |
|---------------------------|---|---|--|---|---|---|---|---|
| |  |  |  |  |  |  |  |  |
| Parça Adı Product Name | Şase Chassis | Polyester Depo Polyester Tank | C96 Pompa C96 Pump | OPR 40-3 Kumanda Opr 40-3 Regulator | 12 m Kol 12 m Boom | Filtre Filter | Kapak Cover | Elek Sieve |
| Ürün Kodu Product Code | 10400001 (SF 1000) 10400002 (SF 1600) 10400003 (SF 2000) | 10003280 (SF 1000) 10003281 (SF 1600) 10003282 (SF 2000) | 10800003 | 11000003 | 10600005 | 10000356 | 10000385 | 10000407 |

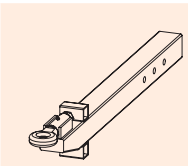
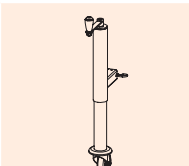
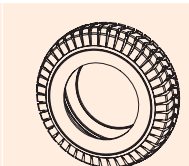
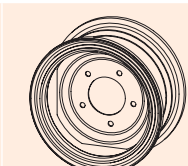
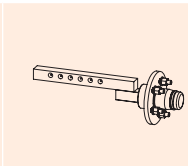
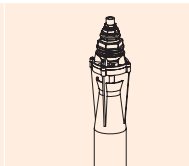
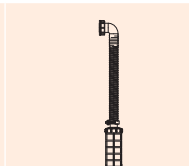
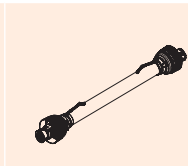
STANDART PARÇALAR
STANDARD PARTS

| | | | | | | | | |
|---------------------------|---|---|--|---|---|---|---|---|
| |  |  |  |  |  |  |  |  |
| Parça Adı Product Name | Çeki Oku Drawbar | Kriko Lever Jack | Lastik Tire | Jant Wheel Rim | Porya Hub | Karıştırıcı Mixer | Hızlı Doldurucu Hortum Kiti Fast Filling Hose | Şaft Shaft |
| Ürün Kodu Product Code | 10400046 | 10400047 | 10000875 (SF 1000) 10000884 (SF 1600) 10000884 (SF 2000) | 10000861 (SF 1000) 10000885 (SF 1600) 10000885 (SF 2000) | 10000268 | 10000408 | 12000058 | 10001220 |

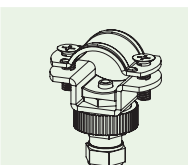
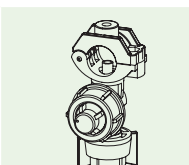
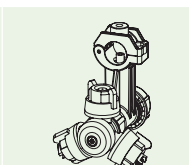
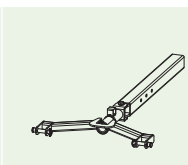
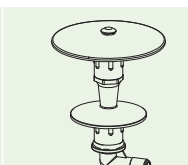

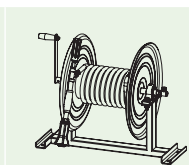

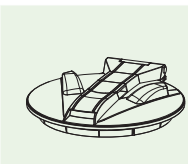
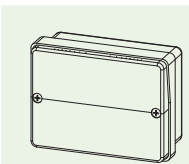
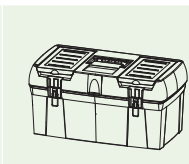
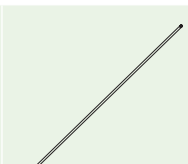
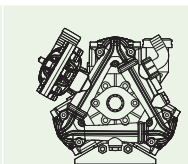

OPSİYONEL PARÇALAR
OPTIONAL PARTS

| | | | | | | | |
|---------------------------|---|---|--|---|---|---|---|
| |  |  |  |  |  |  |  |
| Parça Adı Product Name | Tombul Nozul Conic Brass Nozzle | Yelpaze Hüzmeleli Nozul Single Curtain Spray Nozzle | Üçlü Yelpaze Hüzmeleli Nozul Triple Curtain Spray Nozzle | Döner Kafalı Çeki Oku Revolver Head Drawbar | Toz İlaç Karıştırıcı Powder Chemical Mixer | İlaçlama Tabancası Kiti Spray Gun Kit | Hortum Sarma Makara Kiti Hose Reel Kit |
| Ürün Kodu Product Code | 10000177 | 10000405 | 10000406 | 10400050 | 10003326 | 10002745 | 11000174 |

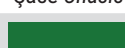
OPSİYONEL PARÇALAR
OPTIONAL PARTS

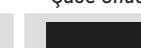
| | | | | | |
|---------------------------|---|---|--|---|---|
| |  |  |  |  |  |
| Parça Adı Product Name | Menteşeli Kapak Hinged Cover | Stop Lambası Stop Light | Takım Çantası Tool Box | Krom İlaçlama Borusu Chrome Pipe | Düşük Basıncılı Pompa Low Pressure Pump |
| Ürün Kodu Product Code | 10003256 | 10000276 | 10001177 | 12000057 | 10800007 |

RENK
SEÇENEKLERİ
COLOR
ALTERNATIVES

| | | | | | | |
|--|---|---|---|--|---|---|
| | 1 | | 2 | | 3 | |
| | Şase Chasis | Depo Storage | Şase Chasis | Depo Storage | Şase Chasis | Depo Storage |
| |  |  |  |  |  |  |
| | Yeşil Green | Turuncu Orange | Siyah Black | Kırmızı Red | Galvaniz Galvanized | Beyaz White |